







# MK Illumination

## Regionales Unternehmen mit globaler Reichweite.

Beeindruckende Inszenierungen und überdimensionale Lichteffekte faszinieren Menschen jeden Alters seit jeher. Damit lässt sich erklären, warum in den letzten 14 Jahren weltweit Nachfrage und Anspruch bei Beleuchtungskonzepten deutlich anstiegen und sich dekorative Beleuchtung als Werbeträger durchsetzte.

Wir sind Europas Marktführer bei dekorativer und energieeffizienter Beleuchtung und verstehen uns als verlässlicher Partner mit breitgefächertem Know-how. Wir betreiben in 23 Länder der Welt eigenständig geführte Tochtergesellschaften, die durch den lokalen und regionalen Bezug schnell und kundenorientiert agieren können. Strategisch gelenkt werden sie von unserer Zentrale in Innsbruck/Österreich. Produktionstechnisch werden sie von einem hochmodernen Betrieb in der Slowakei unterstützt.

### **Kundennähe – Garant bester Ergebnisse**

Internationale Erfahrung, regionales Wissen und der direkte Kontakt ergeben ein MK Service mit Alleinstellungsmerkmal: maßgeschneiderte Motive, Produkte höchster Qualität und kostengünstige Logistik. Wenn wir also innovative Projekte und Konzepte in allen Größenordnungen anbieten, fließen zum einen regionale Kenntnisse mit ein und zum anderen können wir auf ein langjähriges internationales Know-how der gesamten MK Gruppe zurückgreifen. Deshalb vertrauen uns sowohl Einkaufszentren, Hotels und die Gastronomie als auch kommunale und private Einrichtungen.



Nelson Mandela Square, Johannesburg – South Africa

### September 2011 15 Jahre MK Illumination – ein Licht erobert die Welt

Der Blick in die Vergangenheit bedeutet nicht Rückschritt. Rückbesinnung als Wert bringt ein Unternehmen ein schönes Stück nach vorne. Sie resümiert Entwicklung, zeigt Kontinuität und kehrt eigene Stärken hervor. 15 Jahre Planung und Entwicklung von visionären und charakterlich eigenständigen Beleuchtungskonzepten liegen hinter uns, immer am Stand der Technik und den entscheidenden Schritt voraus. Wir setzen Gebäude, Plätze und Städte gefühlvoll in Szene, ziehen damit Menschen magisch an und wecken Emotionen. 15 Jahre Beweisführung für Relevanz, Ausgewogenheit und Verantwortung, gelebte Empathie, Kundenverständnis und Kundennutzen.

# MK Illumination Worldwide



● Unsere Niederlassungen

**Austria (Head office)**  
MK Illumination Handels GmbH  
6020 Innsbruck, Austria  
+43 (0)512 20 24 30  
info@mk-illumination.com

**Hong Kong**  
MK Illumination Hong Kong Ltd.  
Hong Kong  
+86 755 8230 5830  
office@mk-illumination.com.cn

**Portugal**  
Conceitos de Iluminação MK, Lda  
4700-284 Braga  
+351 253 098 022  
info@mk-illumination.pt

**Switzerland**  
MK Illumination AG  
8304 Wallisellen  
+41 44 818 74 00  
info@mk-illumination.ch

**Baltic states**  
MK Illumination Baltic AS  
10112 Tallinn, Estonia  
+372 602 4477  
baltic@mk-illumination.com

**Hungary**  
MK Hungaria Kft.  
9423 Ágfalva  
+36 99 524 247  
info@mk-illumination.hu

**Romania**  
S.c. MK Illumination S.r.l  
Additional markets: Bulgaria, Moldavia  
331057 Hunedoara  
+40 254 712 714  
office@mk-illumination.ro

**Turkey**  
MK Aydınlatma Pazarlama  
Limited Şirketi  
Büyükçekmece - İstanbul  
+90 212 886 72 66  
turkiye@mk-illumination.com

**Belgium**  
MK Illumination Belgium  
3870 Horpmaal  
+32 497 505 504  
info@mk-illumination.be

**Ireland**  
MK Illumination Ireland LTD  
Additional market: Northern Ireland  
Little Island, Cork  
+353 21 4354641  
info@mk-illumination.ie

**Slovakia**  
MK Illumination s.r.o.  
Additional market: Czech Republic  
080 01 Prešov  
+421 51 7495780  
info@mk-illumination.sk

**Ukraine**  
MK Illumination UA  
04080 Kiev  
+380979895794  
a.markevich@mk-illumination.com

**China**  
MK Illumination Design (Shanghai) Co., Ltd.  
Shanghai 200023  
+86 21 60752400  
info@mk-design.cn

**Italy**  
MK Italia S.R.L.  
10073 Ciriè (Torino)  
+39 11 921 26 05  
guido@mk-illumination.it

**South Africa**  
MK Illumination South Africa Ltd.  
3610 Kloof  
+27 83 2560860  
lee@mk-illumination.co.za

**United Kingdom**  
MK Illumination UK Ltd.  
BB3 2EB Darwen Lancashire  
+44 1254 778670  
office@mkillumination.co.uk

**France**  
MK Illumination SAS  
Additional market: North Africa  
30660 Gallargues le Montueux  
+33 4 66 51 05 85  
info@mk-illumination.fr

**Norway**  
MK Illumination AS  
0663 Oslo  
+47 40 632 560  
r.j.hansen@mk-illumination.net

**Spain**  
MK Illumination Iberica XXI, S.L.  
45007 Toledo  
+34 925 233 812  
joseluispretel@grupoprilux.com

**USA**  
MK Illumination USA LLC  
Du Quoin, IL. 62832  
+1 618-542-XMAS (9627)  
J.Espy@mk-illumination.com

**Holland**  
MK Illumination Holland BV  
8140 AA HEINO  
+31 (0) 572.391015  
info@mk-illumination.nl

**Poland**  
MK Iluminacje Polska  
43-300 Bielsko-Biała  
+48 33 821 93 63  
info@mk-iluminacje.pl

**Sweden**  
MK Illumination AB  
27403 Rydsgård  
+46 411 444 41  
info@mk-illumination.se

www.mk-shoppingcenter.com | www.mk-illumination.com

# Our Products.

## Einzigartige Produkte schaffen erstaunliche Lichtwelten.

### PROFESSIONAL LINE.

Hochwertig und flexibel einsetzbar: die Professional Line – das Herzstück unserer Produktpalette. Eine Reihe hochwertiger Lichterketten mit außergewöhnlicher Beschaffenheit, Qualität und Leistung. Diese Produktfamilie imponiert mit dem patentierten QuickFix® System und erleichtert damit eine schnelle und vor allem sichere Installation.



**1. QuickFix® Outdoor 230 V** – robuste und wetterbeständige Gummi-Lichterketten. Die LEDs sind in die Polycarbonatkappen mittels Epoxydharz eingegossen und versiegelt. Das garantiert immer perfekten Kontakt und den sicheren Schutz gegen Nässe. Diese Bauweise in Verbindung mit dem Sicherheitsdrehverschluss gewährleistet nicht nur eine schnelle, leichte und sichere Montage, sondern auch die Schutzart IP44. Alle QuickFix® Outdoor-Lichterketten 230 V sind ausschließlich untereinander koppelbar und Basis für unsere QuickFix® Collection und Collection Reihe. Sie eignen sich hervorragend zur Beleuchtung von Bäumen, Fassaden und ganzen Gebäuden.



**2. QuickFix® Indoor 230 V** – die eleganten, transparenten PVC Lichterketten sind die sichersten Indoorketten am Markt weil die LEDs in die Polycarbonatkappen mittels Epoxydharz eingegossen und versiegelt sind. Die Kabel können somit nicht mehr aus der Fassung gezogen werden, ein dauerhaft perfekter Kontakt ist damit garantiert. Diese Bauweise in Verbindung mit dem Sicherheitsdrehverschluss gewährleistet eine schnelle, leichte und sichere Montage. Alle QuickFix® Indoor-Lichterketten 230 V sind ausschließlich untereinander koppelbar. Bestens geeignet für Christbäume, Girlanden, Kränze und alle Lichtideen für den Innenbereich.



**3. QuickFix® Low Voltage 36 V** – elegant, transparent und gleichzeitig die professionellste Niedervolt Lichterkette am Markt, mit Niedervolttransformator IP67 für den Außen- und Innenbereich. Die LEDs sind in die Polycarbonatkappen mittels Epoxydharz eingegossen und versiegelt. Das garantiert immer perfekten Kontakt und den sicheren Schutz gegen Nässe. Diese Bauweise in Verbindung mit dem Sicherheitsdrehverschluss gewährleistet nicht nur eine schnelle, leichte und sichere Montage, sondern auch die Schutzart IP44. Alle QuickFix® Low Voltage 36 Volt Lichterketten sind ausschließlich untereinander koppelbar. Ideal geeignet für Dekorationen im Handbereich oder wo Niedervolt vorgeschrieben wird.

**4. Leuchtmittel** – Alle Leuchtmittel der Professional Line sind auf dem Stand der Technik und mit reinsten Lichtfarben.

- **FilaLED E27 und E14, jetzt auch als Wechselstrom LED**

Der Rolls Royce unter den LED-Leuchtmitteln. Der optimale Powerfactor von beinahe 1\* belegt die Spitzenqualität der neuesten LED-Technik. Mit nur 2,4 Watt Energieverbrauch ist die FilaLED die effizienteste am Markt. Kein Vorschaltgerät und damit weniger Elektronik, wesentlich geringeren Verschleiß und damit höhere Lebensdauer. So hebt sie sich deutlich von Energiespar- und anderen LED-Lampen ab.

Der speziell geschliffene Kristall im Inneren der FilaLED simuliert die Optik eines Glühfadens perfekt und kommt so der herkömmlichen Glühbirne mit warmweißer Lichtfarbe am nächsten. Die FilaLED gibt's in Kerzen-, Kugel- und Birnenform, sowohl in mattem als auch klarem Glas und ist als einzige dimmbar.

- **Golf Ball E27**

Durch die spezielle Form besitzt der Golf Ball mehr Oberfläche als herkömmliche LED-Leuchtmittel und gibt daher auch mehr Licht ab und überzeugt durch ein herausragendes Preis-Leistungsverhältnis. Das Gehäuse besteht aus mattem oder klarem Polycarbonat, ist somit extrem widerstandsfähig und bruchstabil. Die neue konische Form des Sockels passt sich besonders gut dem Dichtungsring verschiedener, marktüblicher Fassungen an. Somit bestens für den Innen- sowie Außenbereich geeignet.

- **LED Deco Golf Ball E27**

Der Deco Golf Ball ist mit seiner etwas geringeren Leuchtkraft und normaler Kugelform die günstigere Variante. Er schaut zwar der Kugelglühbirne am ähnlichsten hat allerdings nicht für alle unterschiedlichen marktüblichen Fassungen die optimale Passform. Der Deco Golf Ball ist mit warmweißer oder brillantweißer Lichtfarbe, mit mattem oder klarem Polycarbonatgehäuse erhältlich. Achtung: Bei Außenanwendung muss eine passende Fassung samt Silikon Dichttring verwendet werden.

- **Flash-Lights E27, B22**

Diese LEDs oder Strobes blinken in regelmäßigen Abständen kurz auf und simulieren so perfekte „Lichtblitze“, die gerne für Baum- und Fassadendekorationen verwendet werden. Selbstredend, dass damit jedes Motiv alle Aufmerksamkeit auf sich zieht.

- **Prisma E14, 12 Volt**

Wird seit geraumer Zeit gerne als Ersatzleuchtmittel für herkömmliche Glühbirnen bei traditionellen E14 Motiven verwendet. Die Prisma-LED ist in verschiedenen Farben erhältlich und besticht durch das einzigartige Diamantschliff Polycarbonatgehäuse, das ein brillantes Licht entstehen lässt. Zusätzlich sind Prisma-LEDs als Flash-Lights und als RGB-Multicolor mit sanft fließendem Lichtwechsel erhältlich.

**5. Rope Light Outdoor 230 V** – aneinander gereihte, in einem biegsamen PVC-Schlauch eingegossene LED-Lichtpunkte in verschiedenen Farben. Dank des QuickFix® Systems sind alle Rope Light Outdoor 230 V untereinander koppelbar, entsprechen der Schutzart IP44 und sind schnell, leicht und sicher zu installieren. Sehr gut geeignet für Fassaden, Dächer, Konturen und indirekte Beleuchtung. Wichtig: Vergessen Sie nie die Anschlüsse und Endkappen zu verkleben!



**6. Deco & Green** – traditionelle, handgefertigte Dekorationen, Kunstbäume und Grüngirlanden. Komplett mit warmweißen LED Lichtpunkten bestückt und in Top B1 geprüfter Qualität. Die natürliche Farbe des dichten Buschwerks aus Tinsel-Tipps und Spritzguss-Tipps sowie die hohe Dichte an verarbeiteten Tipps geben der Grünware einerseits ein echtes Aussehen und andererseits ein bildschönes, festliches Lichtbild. Und das besondere und einzigartige an MK Girlanden: Jede einzelne Lampe ist jeweils an einem Tipp befestigt und die Kabel wurden ins Innere des Produkts gelegt.



**7. QuickFix® Collection 230 V** – uneingeschränkt und individuell konzipierbare Kleinmotivgruppe. Flexibel einsetzbar weil sie direkt mit der QuickFix® Outdoor Produktreihe verbunden werden können. Bei der Verwendung mit der QuickFix® Indoor Produktreihe ist ein spezieller T-Verbinder notwendig. In dieser Collection werden teilweise „organics materials“ verarbeitet, die zu 100 Prozent recycelbar, wasser- sowie wetterfest und UV-Licht beständig sind.



# Our Products.

Einzigartige Produkte schaffen  
erstaunliche Lichtwelten.

## COLLECTION.

Eine Reihe bester zweidimensionaler Lichtmotive für Straßenlaternen, Hausfassaden  
und Straßenüberspannungen.



Das Sortiment der Collection-Reihe wird laufend durch neue Designideen und Motivgrößen in bewährter MK Qualität erweitert. Bei der Herstellung verwenden wir grundsätzlich neueste LED-Technologie und ab 2011 kombinieren wir sie erstmalig mit – Organic Materials. Die signifikanten Neuerungen dieser Generation sind herausragend und richtungsweisend: 100 Prozent recyclebar, wasser- sowie wetterfest und UV-Licht beständig.

Dazu kommt die neue, kluge Teilintegration des Rahmens in das Motiv, was die Handhabung erleichtert und das Design bereichert, und zwar durch den Tages- und Nachteffekt. Wie das funktioniert? Durch die besondere Materialzusammensetzung entsteht eine sehr reizvolle Oberfläche, die bereits tagsüber bezaubernd schimmert. Nachts werden Engel und Co. durch komplementäre Leuchtmittel aus dem Inneren märchenhaft inszeniert.

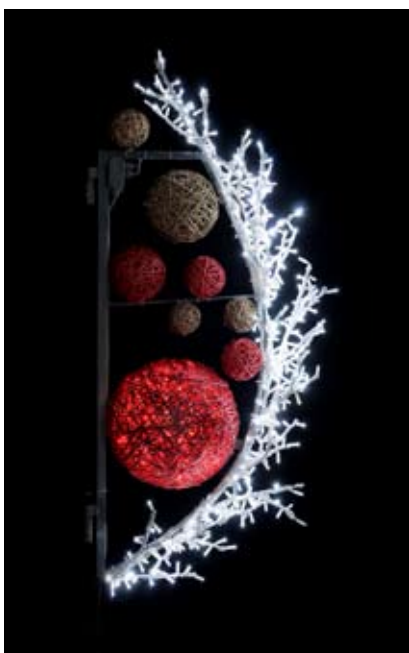



## LIMITED. CONCEPTUAL FESTIVE LIGHTING.

Mit der Liebe zum Detail und exklusiver Handwerkskunst entstehen Unikate mit höchstem Designanspruch: die Limited Serie.

Ideenreichtum formt das Werk zum Spitzenprodukt; es wird zum „Piece of the Art“, ein Einzelstück – stimmungsvoll und besonderen Ansprüchen gerecht. Seit 2009 arbeiten wir in unsere dreidimensionalen Lichtmotive für Innen und Außen edle Kristalltropfen und -perlen ein. Dabei entstehen echte Schmuckstücke, die bei unseren Kunden sehr beliebt sind. Grund genug, für diese exklusive Reihe weiterhin intensiv nach neuen Möglichkeiten zu suchen. Gefunden wurden sie beispielsweise in den stilistischen Richtungen „Glory“ (die Glamourösen) und „Joy“ (die Verspielten).

### 2011: Eine neue, vielversprechende Liäson

Limited Produkte sind Ausdruck besonderer Geschmackssicherheit. Glamourös, exquisit, stilsicher. In der kommenden Saison kombinieren wir Limited-Motive erstmals mit den neuen Organic Materials, den so genannten Biowerkstoffen, bei denen ein wesentlicher Anteil des Materials aus nachwachsenden Rohstoffen gewonnen wird. (Mehr dazu auf Seite 14) Damit stoßen wir Tür und Tor zu völlig neuen Designkonzepten mit frischen Akzenten auf.

### Der Stoff, aus dem die neuen Deko-Träume sind

Eine weitere Novität in diesem Jahr: Die kluge Kombination unserer handgefertigten, dreidimensionalen Motive mit edlen, ausgesuchten Stoffen zu kombinieren – allerdings nur für den Innenbereich. Wir verwenden ausschließlich Materialien, die den europäischen Sicherheitsbestimmungen entsprechen. (B1, M1)

### Ehrliches Handwerk

Die zentrale Geburtsstätte unzähliger Modellideen für die Collection und Limited-Serie befindet sich gleich rechts neben unserer Forschungs- und Entwicklungsabteilung – im hauseigenen Designbüro. Unser Motto „alles unter einem Dach“ ist der Grundstein und ein Qualitätsmerkmal zugleich für den einzigartigen und charakteristischen MK-Stil.

Auf einer Produktionsfläche von über 6.000 m<sup>2</sup> werden unsere Motive nach europäischen Sicherheitsstandards und Normen per Hand und mit viel Geschick von bis zu 180 Mitarbeiter/-innen in der Saison modelliert und gefertigt. Sie durchlaufen permanent Kontrollen, bevor sie das Fabrikgelände verlassen dürfen, um die bewährte MK Wohlfühlstimmung zu verbreiten. Dass solch professionelle „Hände“ ständig und zielgerecht aus- und weitergebildet werden wollen, empfinden wir als selbstverständliche Unternehmensinitiative. Nur so können Unikate entstehen die höchstem Designanspruch gerecht werden.

# MK Illumination

## – das Original

Was ist ein Original und welchen Wert hat es?

Ein Original ist etwas Einzigartiges, etwas noch nie Dagewesenes. Es besitzt Merkmale wie ursprünglich, beständig und Niveau mit denen es Vertrauen und Sicherheit aufbaut. Dadurch entsteht ein gesundes Qualitätsbewusstsein.

Und das hat eben seinen Preis! Und der setzt sich bekanntlich aus verschiedenen Faktoren zusammen. Beispielsweise ist Forschungs- und Entwicklungsarbeit in unserem täglichen Workflow bereits integriert. Es sei auch noch erwähnt, dass innovative Designideen ebenfalls bei uns im Haus entstehen und durch das wiederholte Bauen von Prototypen optimiert zur Umsetzung gebracht werden. Es liegt klar auf der Hand, dass Kenntnisse über kleinste Komponenten, über die Thematik per se, das Kennen von Richtlinien und gesetzlichen Rahmenbedingungen erst ein ungestörtes, qualitativ effektives Arbeiten ermöglichen. Das Resümee unserer langjährigen Marktbeobachtung: Niedrigpreise wurzeln fast immer bei minderer Qualität, Design- und Innovationskraft. Attribute, die wir als europäischer Marktführer gerne erfüllen.



# Wie erkenne ich ein MK Produkt?

## 1. Kennzeichnung der QuickFix® Verbinder

Neu für 2011 produzierte Ware:

- registrierte Musterschutz Identifikationsnummer ist am Verbinder ersichtlich.  
230 Volt – 332473, 36 Volt – 1754508
- blauer Dichtring
- Silberlabel mit allen relevanten Daten und Warnhinweisen
- MK Logo
- nur mehr in eine (Pfeil-)Richtung koppelbar – Polarität

Das QuickFix® Outdoor 230 Volt, Niedervolt 36 Volt und Indoor 230 Volt System ist von einem europäischen Institut geprüft und für den europäischen Markt zugelassen. Die spezielle Verarbeitung der QuickFix® Verbinder macht unsere Lichterketten zu den sichersten in Europa.

Aus Sicherheitsgründen können 230 Volt nicht mit 36 Volt Produkten verbunden werden. Als erster Hersteller garantiert MK die neuen europäischen Sicherheitsstandards (vorhersehbare Fehlanwendung)!

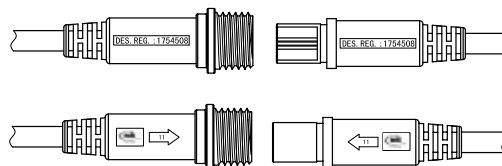

QuickFix® Verbinder – 36 Volt – 1754508



QuickFix® 36V System

QuickFix® 230V System

## 2. Kennzeichnung des Kabels

Alle ab 2011 produzierten MK Kabeln besitzen das neue „MK Printing“ als Qualitätskennzeichnung und Unterscheidungsmerkmal. Die Zertifizierung dieser Kabel nimmt ausschließlich das Deutsche Institut VDE vor. So sind sie immer als Qualitätsprodukt identifizierbar.



MK-Aufdruck

## 3. Neue umweltfreundliche Verpackung

MK pflegt eine nachhaltige Umweltpolitik! Wir drucken nicht auf gebleichtem Papier und verzichten auf umweltschädliche Farben. Jede Verpackung wird mit dem Original Quality Seal (Siegel) versehen und ist Ihre Garantie ein Qualitätsprodukt zu erhalten. Apropos Verpackung: Wir achten darauf, dass jedes MK Produkt seine optimale Verpackungsgröße bekommt, denn das optimiert unsere Logistik und spart wiederum CO<sub>2</sub> Emissionen.



MK Verpackung

## 4. Identifizierung

Jedes MK Produkt verifiziert sich durch gespeicherte und verschlüsselte Daten wie zum Beispiel Herstellungsdatum und dem Qualitätsprüfungsnachweis.

## 5. Internationaler Musterschutz

Wir selbst haben eine Vielzahl an Designs zum Musterschutz registrieren lassen. Deshalb respektieren wir auch andere und nehmen Rücksicht auf diese.



Musterschutz

# MK Illumination

## Light Info / Glossar

### Was heißt eigentlich ...?

#### > LUMEN (LM)

Kommt aus dem lateinischen, heißt „Licht“, „Leuchte“ und ist die Maßeinheit des Lichtstroms. Vereinfacht gesagt, wie hell ein Leuchtkörper strahlt.

#### > WATT (W)

Das Watt (W), benannt nach dem schottischen Erfinder James Watt (18. Jht.), ist die Maßeinheit von Energie pro Zeit und sagt aus, wie viel Energie ein Leuchtkörper konsumiert, respektive, in einer Stunde benötigt, um zu leuchten.

#### > KELVIN (K)

Das Kelvin (K), benannt nach dem britischen Physiker William Thomson, 1. Baron Kelvin (Ende 18. Jht.), ist die Basiseinheit der thermodynamischen Temperatur und beschreibt die Lichtfarbe. MK warmweiß liegt bei 2.000 bis 2.400 Kelvin.

#### > ENERGY LABEL

Beschreibt, wie Energieeffizient ein Leuchtmittel ist.

#### > YEARS / H (Hours) Lebensdauer

Gibt einen ungefähren Überblick in Stunden oder Jahren, wie lange eine Glühlampe /LED „lebt“.

#### > DECORATIVE LIGHT

Ein Wetterleuchten voller Kontraste und Kreativität. Licht setzt Akzente, erschafft beeindruckende Fantasiewelten und Identität, berührt und erzeugt Stimmungen. Dekoratives Licht kann aber auch richtungsweisend sein: nämlich als sichere Orientierungshilfe sowohl in der Markenwahrnehmung als auch als Wegweiser. Wir sehen dekorative Beleuchtung als professionellen Begleiter ‚sinnvoller‘ Marketingaktivitäten.

#### > BRILLIANT LIGHT

Kraftvoll und rein. Punktuell richtig eingesetzt signalisiert es künstlerische Empathie. Brillantes Licht zieht Menschen an und hält fest, durch einen fabelhaft einzigartigen Farbton. Kein anderes Licht verzaubert Winterlandschaften reizvoller und prächtiger.



# MK Illumination

## Die Premium LED

Der goldene Glanz und die damit verbundene Wohlfühlatmosfera machen warmweiß zur meist bevorzugten LED-Farbe bei Dekorations- und Weihnachtsbeleuchtungen. Aber: „warmweiß“ ist nicht gleich „warmweiß“. Unsere Forschungs- und Entwicklungsabteilung hat mit den weltweit renommiertesten LED-Herstellern ein Leuchtmittel entwickelt, das Energieeffizienz und hohe Leuchtkraft mit einem gleichmäßigen Warmweiß-Ton kombiniert. Die LED erzeugt trotz eines erheblich geringeren Stromverbrauchs ein Licht, das dem einer herkömmlichen Glühbirne beeindruckend nahe kommt.

### Kaltweiß heißt bei MK „brillantweiß“.

Denn kein anderes Licht verzaubert Winterlandschaften reizvoller und prächtiger, kraftvoller und reiner. Brillantes Licht zieht Menschen an und hält sie fest, durch einen fabelhaft einzigartigen Farbton.

### Was können „patentierter LEDs“?

Die speziell für MK Illumination angefertigten und patentierten Premium LEDs heißen nicht nur so, sie bieten auch entscheidende Vorteile gegenüber dem Wettbewerb:

- sie werden ausschließlich von einem namhaften Hersteller bezogen
- Nur patentierte LEDs gewähren Rechtssicherheit am Markt.
- Leuchtkraft und Qualität entsprechen den von MK Illumination gesetzten Normen

Plagiate sind illegal, in Billigprodukten eingesetzt und verlieren innerhalb von nur 500 Stunden 50 Prozent und mehr an Leuchtkraft. Premium LEDs von MK hingegen verlieren innerhalb von 10.000 Stunden lediglich ca. 10-20 Prozent ihrer Leuchtkraft. Zusammengefasst heißt das:

- klarere und intensivere Lichtfarben (Kelvin)
- geringer Leuchtkraftverlust (Lumen in Prozent)
- höchste Lebensdauer (Zeit)

**Verlangen Sie vom Hersteller oder Inverkehrbringer einen gültigen Nachweis über die Verwendung patentierter LEDs!**

### MK verwendet ausschließlich Low-Power LEDs

Und diese eignen sich bestens für dekorative und festliche Beleuchtungen da sie kaum Wärme abgeben. Alle MK Produkte sind und werden laufend von anerkannten europäischen Instituten (SLG, Kema, TÜV) geprüft, was Ihnen und Ihren Kunden höchste Sicherheit garantiert.

### Überzeugende Ausstrahlung: Die 360° Lichtstreuung

Viele Hersteller verwenden LEDs mit einem Abstrahlwinkel von 30 Grad. Diese erzeugen einen sehr hellen Punkt, der allerdings nur von einem Blickwinkel gut zu sehen ist. Hat eine LED einen zu engen Abstrahlwinkel, entspricht sie nicht den Anforderungen der Laserklassen, da sie bei zu naher Betrachtung das menschliche Auge schädigen kann.

Anders bei MK LEDs: Wir verwenden nur LEDs die in Polycarbonatkappen mittels Epoxydharz eingegossen und versiegelt sind sowie eine sanfte, perfekte rundum Lichtstreuung verbreiten. Übrigens: Die spezielle Mischung des Klebers unterstützt diese Farbsteuerung, denn sie wirkt wie eine Lupe, verstärkt den Effekt und lässt die LEDs in vollem Umfang noch brillanter funkeln.

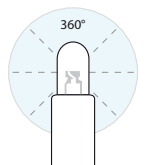

### Die Vorteile von MK Premium LED-Produkten:

Klare Farben und keine UV-Strahlung

Leuchtkraftverlust sehr gering

Höhere Lebensdauer

80-90 Prozent Stromersparnis

Reduktion von CO<sub>2</sub> Emissionen

Bruchsicheres Gehäuse aus klarem oder mattem Polycarbonat

Stoßfest und vibrationsunempfindlich

# Entwicklung neuer Produkte

Das heißt für uns natürlich voraus, aber in vielen Belangen vor allem quer zu denken. Denn nur so entstehen Symbiosen der Einzigartigkeit. Und ein eigener, typischer MK Stil in Ausdruckskraft und Umsetzung. Avantgardistisches Gedankengut und althergebrachtes als knisterndes Spannungsfeld für Neues. Attribute wie Energieeffizienz, Umweltverträglichkeit und Technologie am Stand sind für uns selbstverständlich. Wir wollen unserer Klientel neueste Produkte anbieten, die den Puls der Zeit treffen und den jüngsten volkswirtschaftlichen und marktrelevanten Veränderungen Rechnung tragen.



## **MK Organic – der Advent wird „grün“**

Als weltweit erster Hersteller produzieren wir verschiedenste Weihnachtsmotive aus ‚Organic Materials‘. Bei all‘ unseren Aktivitäten betreiben wir kein so genanntes Greenwashing, nur weil nachhaltiger Umweltschutz im Sinne von Rohstoff- und Ressourceneffizienz ein Megatrend ist. Viel wichtiger ist uns, einen nachweisbaren und die Umwelt schonenden Fußabdruck zu hinterlassen. Das ist auch der Grund, warum wir schon bei der Auswahl diverser Materialien umweltbewusst vordenken und uns für Organic Materials entschieden. Diese sind nämlich zu 100 Prozent recyclebar, wasser- sowie wetterfest und UV-Licht beständig. Schon bei der Materialauswahl umweltbewusst denken – dieser sehr erfolgreiche Weg, der mit den LEDs begann, ist seit Jahren fixer Bestandteil unserer Unternehmensphilosophie.

## **Neu ab 2011: Die Professional Line Produkte ohne Netzstecker**

Ab 2011 werden alle Lichterketten der Professional Line ohne Stecker geliefert weil es die Montage erheblich vereinfacht. Noch dazu schonen Sie die Umwelt weil das Entsorgen der mehrfach übrigbleibenden Stecker wegfällt. Vergessen Sie allerdings nicht Ihren landesspezifischen Netzstecker mindestens ein Mal separat zu bestellen.

## **Das MK Illumination Low Voltage System™**

Mit der Saison 2010 haben wir unsere Professional Line um eine komplett transparente Niedervolt-Produktfamilie erweitert. Diese verbindet alle Vorteile eines Niedervoltsystems mit der Qualität der MK Professional-Reihe sowie dem patentierten QuickFix® SYSTEM. Für den Innen- und Außenbereich entwickelt, sorgen ein transparentes Kabel, Polycarbonatkappen und der 360-Grad-Leuchteffekt für einen eleganten Auftritt. Besondere Sicherheit garantieren die Transformatoren der Schutzklasse IP 67.





## Umwelt

Als Protagonist der Branche haben wir es uns zur Aufgabe gemacht Kunden nicht nur die beste, sondern – im Sinne eines nachhaltig grünen Fußabdrucks – auch die umweltfreundlichste Beleuchtungstechnik zu bieten. Aus der Klarheit zur Verantwortung gegenüber Mensch und Umwelt entstand deshalb in den vergangenen Jahren einerseits unser erweitertes Selbstverständnis, andererseits die Verpflichtung energieeffiziente Leuchtmittel sowohl selbst zu verwenden als auch intensiv für deren Einsatz zu werben. Auf diesem Weg wollen wir unseren Beitrag dazu leisten, die CO<sub>2</sub>-Emissionen und ihre Folgeschäden nachhaltig zu reduzieren.

### Einleuchtend: Unsere LED-Technologie

Sie ist die erste Wahl bei dekorativer Beleuchtung. Wir von MK Illumination investieren viel Zeit und Geld in die Weiterentwicklung dieser Technologie. Auch unsere Kunden sind von diesem „Licht der Zukunft“ überzeugt weil es auch in größeren Dimensionen funktioniert. LEDs belasten durch ihren extrem niedrigen Energieverbrauch kaum die Umwelt, schonen also die Ressourcen und das Portmonee aller.

### Generation „Biowerkstoffe“: unsere Motive wachsen wieder nach.

Der Anteil an „Biowerkstoffen“ in unserer Produktion steigert sich von Monat zu Monat. Die so genannten „nachwachsenden Rohstoffe“ basieren vollständig oder in relevantem Maße auf Agrarrohstoffen wie beispielsweise Stärke, Zucker, Pflanzenöle und Cellulose (Holz, Naturfasern, Stroh) sowie spezielle Biomoleküle wie Lignin oder Kautschuk. Der Anteil dieser Agrarrohstoffe im Werkstoff beträgt mindestens 20 Prozent. Die Benennung „Biowerkstoffe“ ist noch frisch und jugendlich. Sie wird erst seit wenigen Jahren als „Familienname“ für die neuen biobasierten Werkstoffen verwendet.

Die von uns entwickelten „organic materials“ weisen deutlich mehr als 20 Prozent Agrarrohstoffe auf. Wir sprechen daher berechtigterweise von Biowerkstoffen weil:

- ein wesentlicher Anteil des Werkstoffes aus nachwachsenden Rohstoffen gewonnen wird
- der Anteil petrochemischer Ausgangsrohstoffe signifikant reduziert wurde
- die CO<sub>2</sub>-Bilanz deutlich besser ausfällt
- die rohstoffbezogene Nachhaltigkeit steigt

### Gut ist nicht gut genug!

Zukünftig arbeiten wir mit Lieferanten, die Holz aus nachhaltig kontrollierter Forstwirtschaft aus einem Umkreis von vorgenommenen 50 km verwenden, inkl. dem PEFC-Zertifikat (PEFC – Programme for the Endorsement of Forest Certification Schemes).

### Zurück zur Natur: die organische Plastikpflanze.

Dass Kunststoff in Pflanzen wächst, hätten auch wir nicht für möglich gehalten. Nun, ganz so ist es nicht. Allerdings verwenden wir seit kurzem Kunststoffe, deren Bestandteile zu fast 100 Prozent auf nachwachsenden Komponenten basieren. Mit anderen Worten: *Der Rohstoff für Kunststoff wird aus einer Pflanze gewonnen, und nicht aus Erdöl!*



# QuickFix® Outdoor

## 100% LED

ohne  
Netzstecker

**QuickFix® Outdoor 230 V** – robuste und wetterbeständige Gummi-Lichterketten. Die LEDs sind in die Polycarbonatkappen mittels Epoxydharz eingegossen und versiegelt. Das garantiert immer perfekten Kontakt und den sicheren Schutz gegen Nässe. Diese Bauweise in Verbindung mit dem Sicherheitsdrehverschluss gewährleistet nicht nur eine schnelle, leichte und sichere Montage, sondern auch die Schutzart IP44. Alle QuickFix® Outdoor-Lichterketten 230 V sind ausschließlich untereinander koppelbar und Basis für unsere QuickFix® Collection und Collection Reihe. Sie eignen sich hervorragend zur Beleuchtung von Bäumen, Fassaden und ganzen Gebäuden.

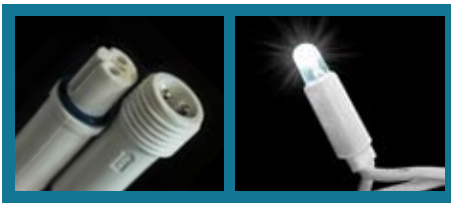

QuickFix® Outdoor kompatibel  
kein Trafo notwendig  
koppel- und erweiterbar  
Segmente austauschbar  
Schutzart IP44  
ohne Netzstecker  
inklusive Endkappe

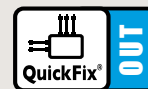

Street decoration



Tree decoration



Building decoration



# QuickFix® Decorations

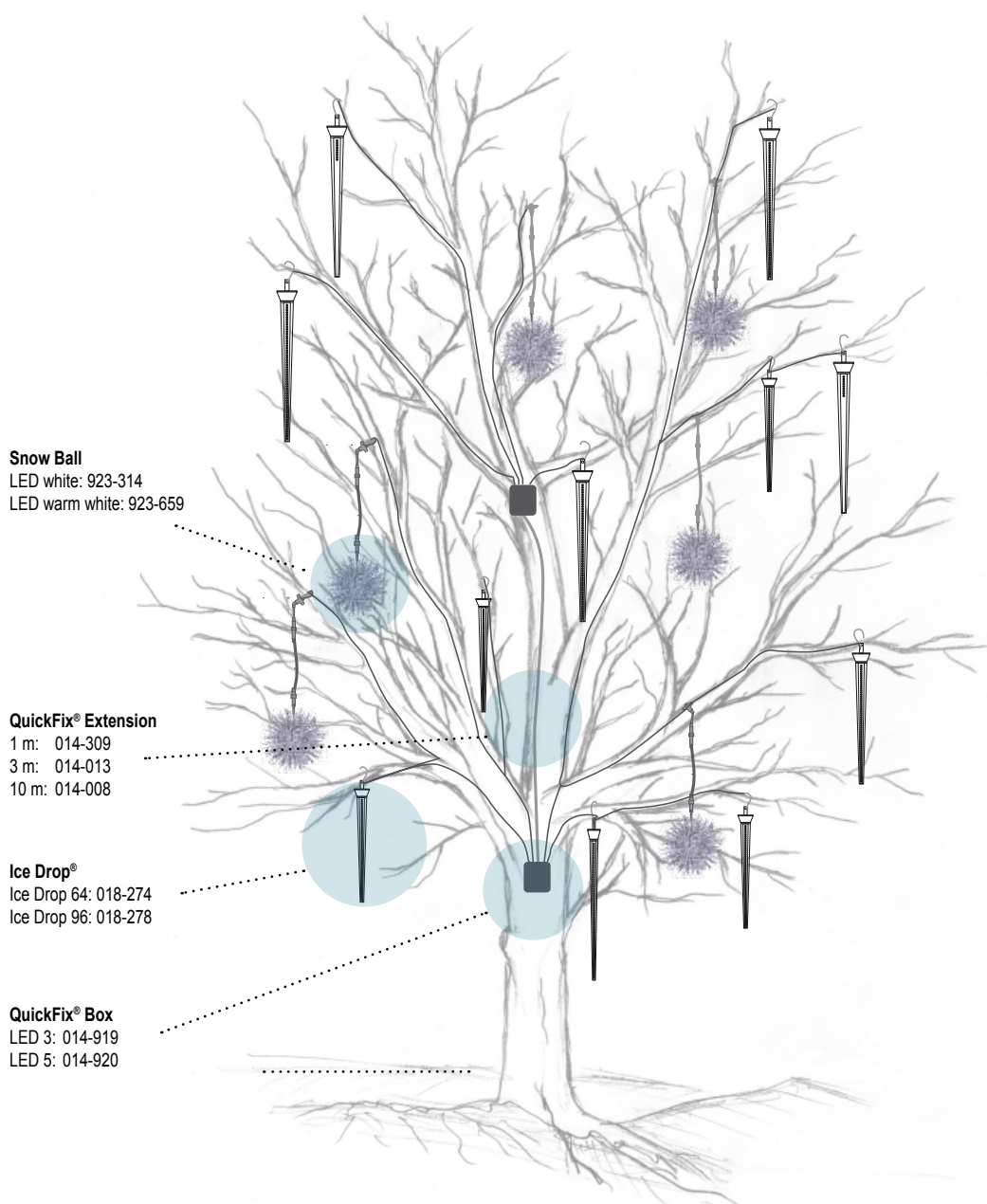

# QuickFix® SYSTEM

DIVIDER, EXTENSION

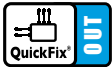

- verbindet gekennzeichnete 230V Outdoor Produkte
- einzeln qualitätsgeprüft
- Schutzart IP44

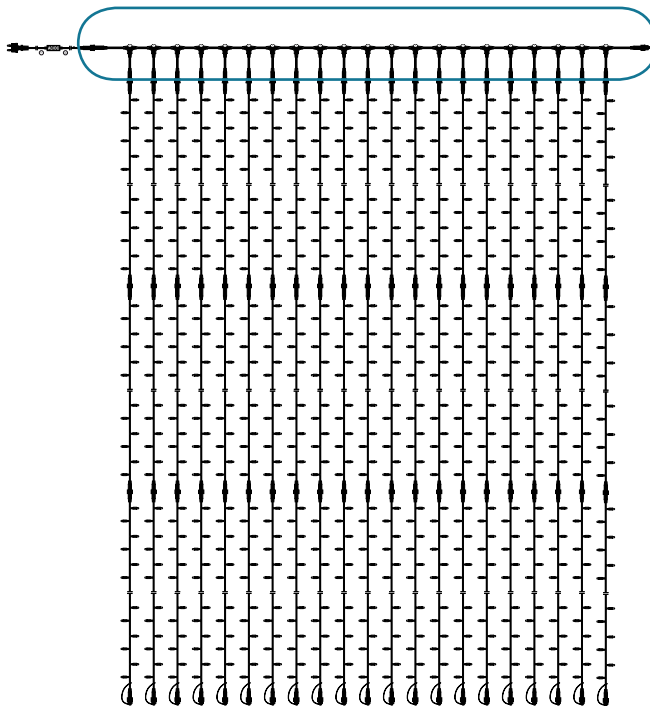
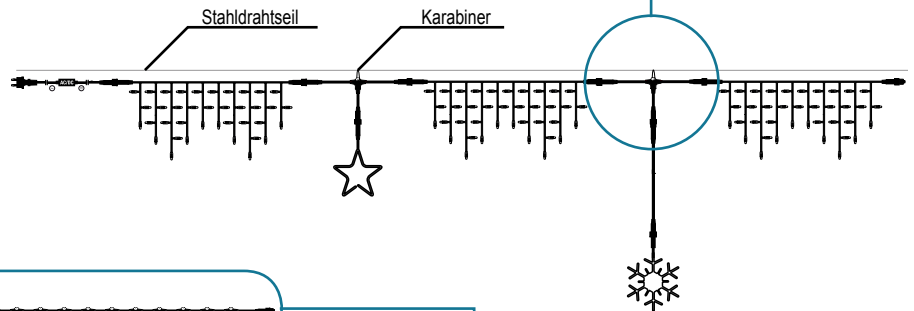

## **XL DRAPE LITE® (=QuickFix® mit STRING LITE®)**

Für große Fassaden und Flächen - mit 8m und mehr! Durch das Verbinden von STRING LITE® mit einem QuickFix® Verteiler erhalten Sie eine einfach und schnell zu realisierende Großdekoration.  
TIPP: Zur Vermeidung kostspieliger Neumontagen, können bei Wartungsarbeiten die Segmente einzeln getauscht werden.

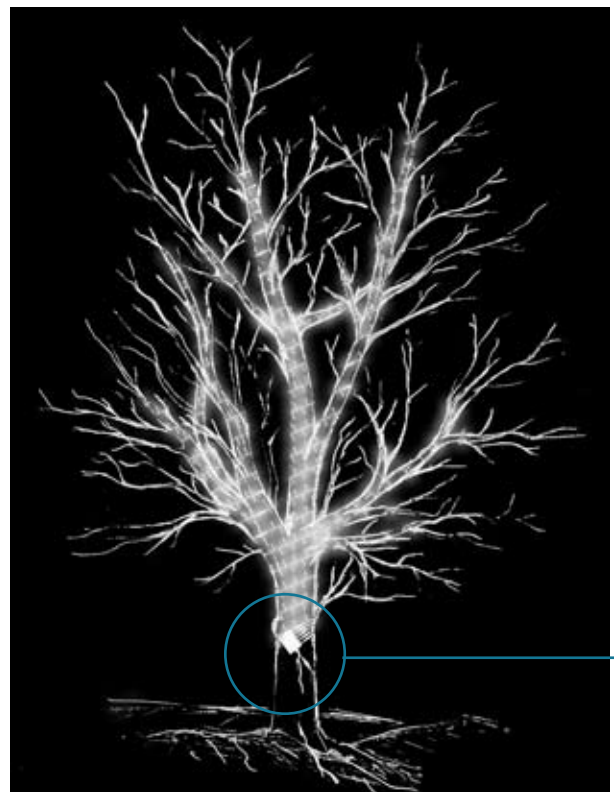

## QuickFix® Divider 2

T-Verbinder, Verteilerkabel mit 2 Ausgängen

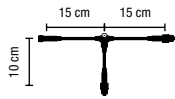
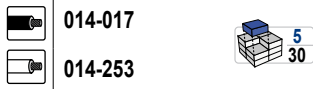

## QuickFix® Divider 3

Verteilerkabel mit 3 Ausgängen

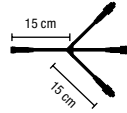
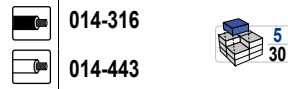

## QuickFix® Divider 7

Verteilerkabel mit 7 Ausgängen

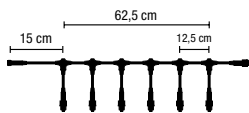
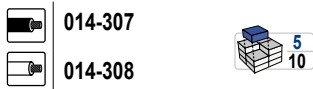

## QuickFix® Divider 12

Verteilerkabel mit 12 Ausgängen

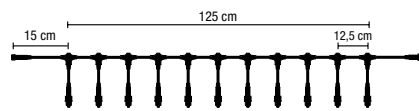
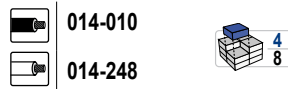

## QuickFix® Divider 22

Verteilerkabel mit 22 Ausgängen

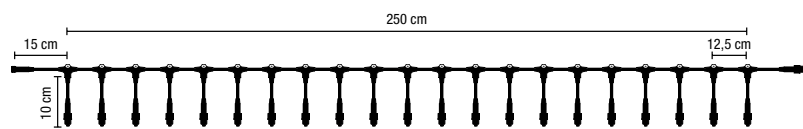
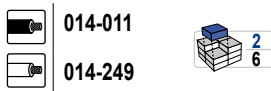

Max. Belastbarkeit des Hauptkabels: 1800W  
Pro Ausgang das Maximum der zu koppelnden Gummiprodukte nicht überschreiten!

## QuickFix® LED-Box 3

Verteilerdose zum Anschließen von QuickFix® LED Produkten, IP44, mit eingebauter Überlastsicherung  
Summe aller Ausgänge darf 1800W nicht überschreiten  
max. Belastbarkeit pro Ausgang: 1800W  
Zuleitung: QuickFix® Outdoor

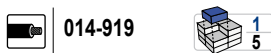

ohne Netzstecker



## QuickFix® LED-Box 5

Verteilerdose zum Anschließen von QuickFix® LED Produkten, IP44, mit eingebauter Überlastsicherung  
Summe aller Ausgänge darf 1800W nicht überschreiten  
max. Belastbarkeit pro Ausgang: 1800W  
Zuleitung: QuickFix® Outdoor

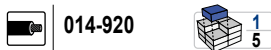

ohne Netzstecker



# QuickFix® SYSTEM

CONNECTOR, ADAPTER

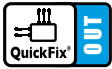

- verbindet gekennzeichnete 230V Outdoor Produkte
- einzeln qualitätsgeprüft
- Schutzart IP44

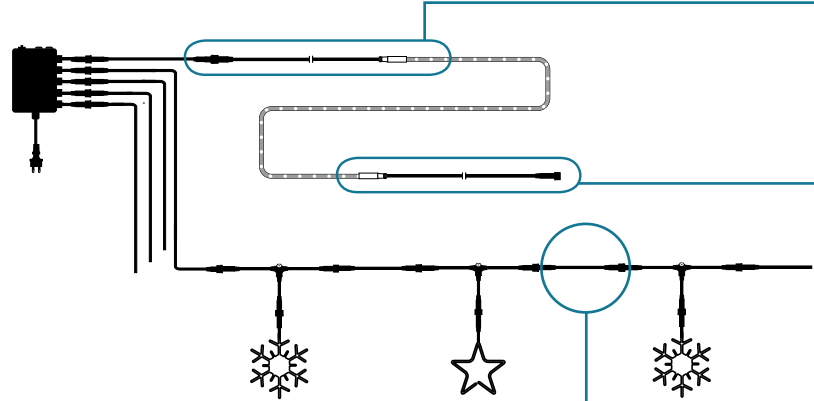

## QuickFix® Extension 1

Verlängerungskabel 1m  
max. Belastbarkeit: 1800 W



## QuickFix® Extension 3

Verlängerungskabel 3m  
max. Belastbarkeit: 1800 W

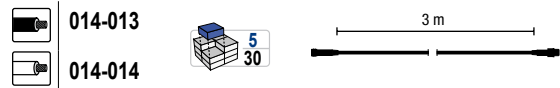

## QuickFix® Extension 10

Verlängerungskabel 10m  
teilbar in 2 Segmente à 5m  
max. Belastbarkeit: 1800 W

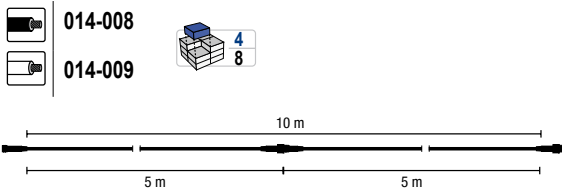

## QuickFix® Accessories

**015-030**  
3 Endkappen,  
3 O-Ringe,  
3 Schrumpfschläuche



**NEW!**

## QuickFix® 2/4 Track Adapter

inkl. 2 weiße Schrumpfschläuche,  
2 schwarze Schrumpfschläuche

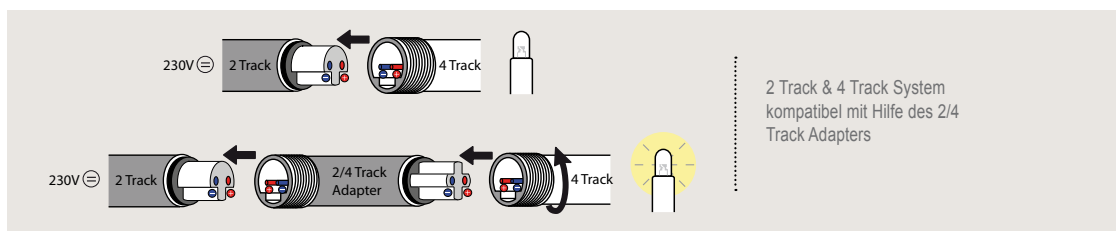

## QuickFix® RopeLight Adapter

Adapter: ROPE LIGHT an QuickFix®  
mit Endkappe, Lösungsmittelkleber, Einspeisepin und 2 Schrumpfschläuchen  
max. Belastbarkeit: 740 W

	<b>244-033</b>		10
	<b>244-034</b>		50
	<b>244-244</b>		10
			50

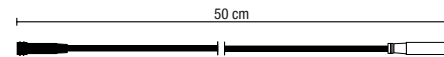

## QuickFix® RopeLight Extension to QuickFix®

Adapter: ROPE LIGHT an QuickFix®  
mit Endkappe, Lösungsmittelkleber, Einspeisepin und 2 Schrumpfschläuchen  
max. Belastbarkeit: 740 W

	<b>244-230</b>		10
	<b>244-231</b>		50
	<b>244-245</b>		10
			50



## LED QuickFix® Outdoor Adapter

Adapter: LED Gummiprodukte an QuickFix®  
max. Belastbarkeit: 480 W

	<b>014-244</b>		5
	<b>014-246</b>		30

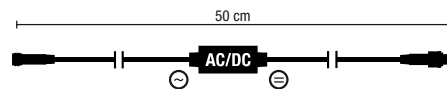

## QuickFix® Main Connector

Anschluss: Zuleitung an QuickFix®  
max. Belastbarkeit: 1800 W

	EU	UK	CH	
	<b>014-233</b>	<b>015-066</b>	<b>015-067</b>	
	<b>014-234</b>	<b>015-068</b>	<b>015-069</b>	

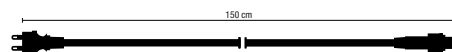

## LED QuickFix® Main Connector

Anschluss: Zuleitung an LED QuickFix®  
max. Belastbarkeit: 480 W

	EU	UK	CH	
	<b>014-418</b>	<b>015-070</b>	<b>015-071</b>	
	<b>014-419</b>	<b>015-072</b>	<b>015-073</b>	

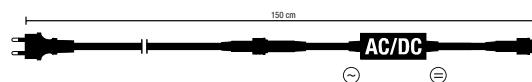



# QuickFix® ANIMATION

## LED-BOXES

### QuickFix® BOXES PRE-PROGRAM

#### QuickFix® LED-Box 4anim

 015-587



Verteilerdose zum Anschließen von QuickFix® LED Produkten, IP44, mit eingebauter Überlastsicherung  
Summe aller Ausgänge darf 800W nicht überschreiten  
max. Belastbarkeit pro Ausgang: 200W  
Zuleitung: Schutzkontaktstecker (10-16A) IP44, 3x1,5mm<sup>2</sup>, 220-240 V mit AC/DC Wandler und aktivem PFC (PF 0,95)  
Zuleitungslänge: 1m

##### Animationseffekte

blinken (alle Ausgänge gleichzeitig, Geschwindigkeit in Stufen regelbar)  
dimmen (alle Ausgänge gleichzeitig, Geschwindigkeiten in Stufen regelbar)  
Wellen (Ausgänge hintereinander, Geschwindigkeiten in Stufen regelbar)  
Dauerlicht



#### QuickFix® LED-Box 8anim

 015-588



Verteilerdose zum Anschließen von QuickFix® LED Produkten, IP44, mit eingebauter Überlastsicherung  
Summe aller Ausgänge darf 800W nicht überschreiten  
max. Belastbarkeit pro Ausgang: 100W  
Zuleitung: Schutzkontaktstecker (10-16A) IP44, 3x1,5mm<sup>2</sup>, 220-240 V mit AC/DC Wandler und aktivem PFC (PF 0,95)  
Zuleitungslänge: 1m

##### Animationseffekte

blinken (alle Ausgänge gleichzeitig, Geschwindigkeit in Stufen regelbar)  
dimmen (alle Ausgänge gleichzeitig, Geschwindigkeiten in Stufen regelbar)  
Wellen (Ausgänge hintereinander, Geschwindigkeiten in Stufen regelbar)  
Dauerlicht



### QuickFix® BOXES dmx

#### QuickFix® LED-Box 4dmx

 015-589



4-Kanal DMX Dimmer zum Anschließen von QuickFix® LED Produkten IP 44 mit eingebauter Überlastsicherung und aktivem PFC (PF 0,95)  
Summe aller Ausgänge darf 800W nicht überschreiten  
max. Belastbarkeit pro Ausgang: 200 W  
Zuleitung Schutzkontaktstecker (10-16A), 3x1,5mm<sup>2</sup>  
4 unabhängige DMX Steuerkreise mit DC Ausgang  
Adressierung über Dipschalter, kompatibel mit USITT DMX512-A Protokoll

#### QuickFix® LED-Box 8dmx

 015-590



8-Kanal DMX Dimmer zum Anschließen von QuickFix® LED Produkten IP 44 mit eingebauter Überlastsicherung und aktivem PFC (PF 0,95)  
Summe aller Ausgänge darf 800W nicht überschreiten  
max. Belastbarkeit pro Ausgang: 100 W  
Zuleitung Schutzkontaktstecker (10-16A), 3x1,5mm<sup>2</sup>  
8 unabhängige DMX Steuerkreise mit DC Ausgang  
Adressierung über Dipschalter, kompatibel mit USITT DMX512-A Protokoll



## QuickFix® Boxes xbee

### QuickFix® LED-Box 4xbee

**015-591**



4-Kanal DMX Dimmer zum Anschliessen von QuickFix® LED Produkten IP 44 mit eingebauter Überlastsicherung und aktivem PFC (PF 0,95)  
 Summe aller Ausgänge darf 800W nicht überschreiten  
 max. Belastbarkeit pro Ausgang: 200 W  
 Zuleitung Schutzkontaktstecker (10-16A), 3x1,5mm<sup>2</sup>  
 4 unabhängige DMX Steuerkreise mit DC Ausgang  
 Adressierung über Dipschalter, kompatibel mit USITT DMX512-A Protokoll  
 unser WirelessDmx erlaubt Ihnen die sichere Übertragung von DMX-Daten per Funk  
 (die Reichweite ist abhängig von den örtlichen Gegebenheiten)  
 Zuleitungslänge: 1m

### QuickFix® LED-Box 8xbee

**015-592**



8-Kanal DMX Dimmer zum Anschliessen von QuickFix® LED Produkten IP 44 mit eingebauter Überlastsicherung und aktivem PFC (PF 0,95)  
 Summe aller Ausgänge darf 800W nicht überschreiten  
 max. Belastbarkeit pro Ausgang: 100 W  
 Zuleitung Schutzkontaktstecker (10-16A), 3x1,5mm<sup>2</sup>  
 8 unabhängige DMX Steuerkreise mit DC Ausgang  
 Adressierung über Dipschalter, kompatibel mit USITT DMX512-A Protokoll  
 unser WirelessDmx erlaubt Ihnen die sichere Übertragung von DMX-Daten per Funk  
 (die Reichweite ist abhängig von den örtlichen Gegebenheiten)  
 Zuleitungslänge: 1m



## Systemübersicht

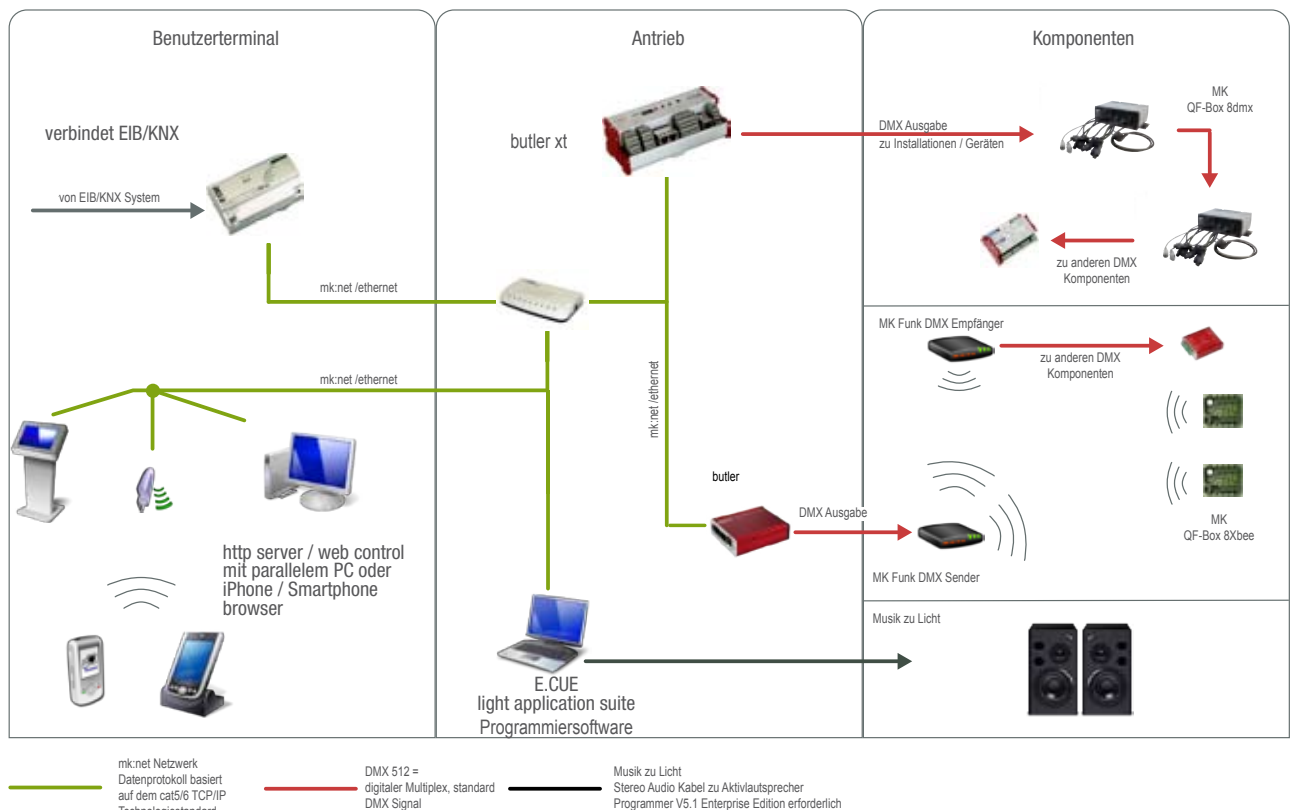

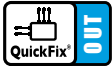

# QuickFix® ANIMATION

## CONTROLLER & ACCESSORIES

### UPGRADE KIT



#### MK DMX Con 1.0 Kit

**015-044**

upgrade kit um aus der QuickFix® Box 4anim und 8anim einen vollwertigen DMX Dimmer zu machen.

Set besteht aus:

- \* DMX - Platine
- \* DMX Ein- und Ausgangskabel
- \* Blindverschraubungen



#### MK DMXbee 1.0 Kit

**015-045**

upgrade kit um aus der QuickFix® Box 4anim, 8anim, 4dmx und 8dmx einen vollwertigen Wireless - DMX Dimmer zu machen.

Set besteht aus:

- \* DMX - Platine incl. Funkmodul
- \* Empfangsantenne
- \* Blindverschraubungen



### DMX CONTROLLER

#### MK E:CUE Butler DMX Output Device

**015-046**

- \* 2 DMX Universalausgänge (1024 Kanäle)
- \* 100 MBit MK:net
- \* Eingebauter IR-Empfänger für RC5
- \* Intere MicroSD Karte für die Speicherung der Konfigurationsdaten



#### MK E:CUE Butler XT DMX Output Device

**015-047**

- \* 2 DMX Universalausgänge (1024 Kanäle)
- \* unterstützt bis zu 8 e:bus Geräte (Glass Touch Serie)
- \* 2 frei konfigurierbare Bedienelemente
- \* 5 LEDs und 7-stelliges LED-Display für Statusinformationen
- \* 100 MBit e:net
- \* Serieller Eingang (RS-232) für Anschluss von Fremdgeräten
- \* Eingebauter IR-Empfänger für RC5 und Traxon Remote IR
- \* 8 frei konfigurierbare (optisch isoliert) Digitaleingänge
- \* microSD Karte als Speicher für Konfigurationsdaten
- \* Eingebaute Echtzeituhr
- \* Astronomische Uhr
- \* Frei konfigurierbare Aktionen für Stand-Alone Betrieb(e.g. play, pause, fortsetzen, stop, zurück und weiter in Abspielliste, wiederholen/abbrechen, schneller vorlauf/rücklauf, Helligkeit (plus/minus)
- \* Haupthelligkeit dimmbar
- \* RDM-vorbereitet



### GATEWAY

#### MK E:CUE Connect EIB/KNX DMX Gateway

**015-048**

connect EIB/KNX leitet Nachrichten aus dem EIB/KNX-System in das e:cue Netzwerk weiter.

So lassen sich Tastsensoren sowie umfangreiche Signale aus der EIB/KNX-Gebäudeleittechnik zur Ansteuerung vieler MK/e:cue Produkte nutzen. Die Kombination beider Technologien verbindet das Beste aus zwei Welten: EIB/KNX als robuste, weltweit verzweigte intelligente Haustechnik für den universellen Einsatz einerseits, und e:cue als Steuerung für komplexe Sonderbereiche wie Fassadenbeleuchtung mit extremer Kanalzahl und unübertroffener Dynamik und Vielseitigkeit andererseits.



### TOUCH SCREEN

#### TOUCH SCREEN

Bedienung der MK e:cue application suites per Fingerdruck.

- \* stabile Bauweise
- \* versiegelter Touchscreen
- \* Anschluss per USB oder seriellem Kabel
- \* Standfuß abnehmbar
- \* On screen Display ( OSD ) zur einfachen Einstellung von Helligkeit, Kontrast, Auflösung etc...

**015-060 15"**

**015-061 17"**



## LIGHTING APPLICATION SUITE / SOFTWARE

### Lighting application suite 5.x

- Die MK/e:cue lighting application suite (LAS) ist ein Windows™ Softwarepaket zur Erstellung einfacher bis komplexer Lichtszenen und Showabläufe.
- Programmierung und Steuerung aller MK Animations-Produkte
- spezielle Multimedia-Funktionen sowie eine automatisierte oder interaktive Ablaufsteuerung
- Programmierer unterstützt in der aktuellen Version bis zu 128 DMX Universen (65536 DMX Kanäle)
- Die von der Software generierte DMX-Steuerung wird über MK/e:cue DMX-Ausgabegeräte realisiert.



### Lighting application suite 5.x Standard

#### 015-050

LAS standard 5.x ist kostenlos



1

### Lighting application suite 5.x Elements

#### 015-051

LAS elements 5.x enthält einen Lizenzschlüssel in USB Form und erlaubt es, Multimedia Funktionen wie den Media Player und den Audio DSP zu nutzen, ermöglicht den Export von Cuelisten auf den e:cue butler und zusätzlich die Verwendung eines externen Signals wie z.B. Midi, RS-232 oder SMPTE Timecode.



1

### Lighting application suite 5.x Enterprise

#### 015-052

LAS enterprise 5.x Version schliesst alle genannten Funktionen der „LAS elements“ mit ein, enthält ebenfalls einen USB Lizenzschlüssel und bietet zusätzlich die Möglichkeit zur Einbindung von bis zu 5 externen Signalen. Zusätzlich ist außerdem die Ausgabe eines Artnet-Universums möglich. Mit der „Unlimited Automation Option“ kann eine unbegrenzte Anzahl von externen Signalen verwendet werden. Mit der „Artnet Upgrade Option“ kann die „LAS enterprise 5.x“ in Schritten um die Ausgabe von 8, 16, 32 oder 64 Artnet Universen erweitert werden, und somit die Möglichkeit der parallelen Steuerung von DMX Lampen (auf Basis von MK/e:cue DMX Ausgabe Interfaces) und Artnet Lampen (Auf Basis einer zusätzlichen Netzwerkverbindung).



1

## ACCESSORIES

### MK Xbee Transmitter

DMX - Funk Ausgabegerät mit einer max. Sendeleistung von 1mW. zum Senden der DMX Signale an die QuickFix® Boxen xA xbee. Die Reichweite ist von den örtlichen Gegebenheiten abhängig. Aufgrund der verwendeten zigbee Funkmodule im 2,4GHz-Bereich ist eine hohe Betriebssicherheit möglich.

**015-053 1 mW**

**015-054 10 mW**



1

### MK Xbee Receiver

#### 015-055

DMX - Funk Empfangsgerät zum Empfangen der DMX Signale von MK xbee Transmitter und Ausgabe auf drahtgebundenes DMX, zur Einbindung von Standard DMX - Geräten. Die Reichweite ist von den örtlichen Gegebenheiten abhängig. Aufgrund der verwendeten zigbee Funkmodule im 2,4GHz-Bereich ist eine hohe Betriebssicherheit möglich.



1

### DMX Cable

vorkonfektioniertes DMX-Datelkabel  
MK DMX Datenkabel zeichnen sich durch exzellente Signalkompatibilität aus. Das Kabel ist UV-beständig, lösungsmittelfest und mechanisch beanspruchbar. Durch doppelte Schirmung werden beste EMV-Eigenschaften erreicht.

**015-056 5m**

**015-057 10m**

**015-058 20m**



1



### DMX Terminator

#### 015-059

DMX - Leitungen müssen am letzten angeschlossenen Gerät durch einen aufzusteckenden Abschlusswiderstand (120 Ohm) terminiert werden.



1



# STRING LITE®





*light impressions*

# STRING LITE® 90

Rubber 230 V



- QuickFix® Outdoor kompatibel
- kein Trafo notwendig
- hohe Leuchtkraft
- koppel- und erweiterbar





## LED STRING LITE® 90

Länge: 4.5m  
 Anzahl der Segmente: 1  
 Lampen pro Segment: 90  
 Länge pro Segment: 4.50 m  
 220-240 V, 7 W, LED: 90  
**ohne Netzstecker**

**018-238**  
 LEDPLR-90-230VSW-WW

**018-237**  
 LEDPLR-90-230VSW-WH

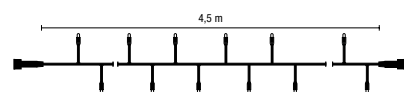

1 Kette = 1 Segmente á 4.5 m, max. 16 Ketten koppelbar



## LED QuickFix® Main Connector

Anschluss: Zuleitung an LED QuickFix®  
 mit Gleichrichter, max. Belastbarkeit: 480 W



## LED QuickFix® Outdoor Adapter

Adapter: LED Gummiprodukte an QuickFix®  
 mit Gleichrichter, max. Belastbarkeit: 480 W



### Was kann bei Dekorationen von eng gewickelten Ästen und Bäumen passieren?

Der dekorierte Baum wächst und dehnt sich aus. Dies kann zur Folge haben, dass Kabel einer normalen Lichterkette stark gedehnt werden und reißen. Die spezielle Lichterkette STRING LITE® 90 ist mit Sollbruchstellen versehen, die zusätzlich Kabel freigeben können und dadurch das Risiko eines Kabelbruches vermindern. Die STRING LITE® 90 hat eine maximale Dehnbarkeit von 25% und kann also um ¼ Ihrer Originallänge „wachsen“.

# STRING LITE® 120

Rubber 230 V



- QuickFix® Outdoor kompatibel
- kein Trafo notwendig
- hohe Leuchtkraft
- koppel- und erweiterbar
- Segmente austauschbar





## LED STRING LITE® 120 – 20m

Länge: 20m  
 Anzahl der Segmente: 2  
 Lampen pro Segment: 60  
 Länge pro Segment: 10.00 m  
 220-240 V, 7 W, LED: 120  
**ohne Netzstecker**



- 018-309**  
LEDPLR-120-230VWH-WW
- 018-310**  
LEDPLR-120-230VSW-WW
- 018-324**  
LEDPLR-120-230VWH-WH
- 018-323**  
LEDPLR-120-230VSW-WH

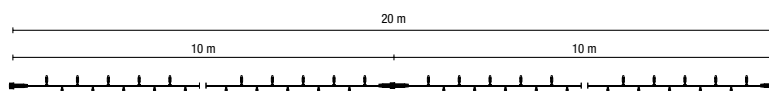

1 Kette = 2 Segmente à 10.0 m, max. 10 Ketten koppelbar

## LED STRING LITE® 120 – 12m

Länge: 12m  
 Anzahl der Segmente: 3  
 Lampen pro Segment: 40  
 Länge pro Segment: 4.00 m  
 220-240 V, 10.5 W, LED: 120  
**ohne Netzstecker**



- 018-311**  
LEDPLR-120-230VWH-WW
- 018-312**  
LEDPLR-120-230VSW-WW
- NEW!** **018-357**  
LEDPLR-120-230VWH-WH
- NEW!** **018-358**  
LEDPLR-120-230VSW-WH

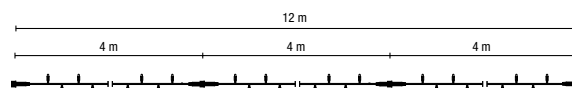

1 Kette = 3 Segmente à 4.0 m, max. 10 Ketten koppelbar

## LED QuickFix® Main Connector

Anschluss: Zuleitung an LED QuickFix®  
 mit Gleichrichter, max. Belastbarkeit: 480 W



	EU	UK	CH
	<b>014-418</b>	<b>015-070</b>	<b>015-071</b>
	<b>014-419</b>	<b>015-072</b>	<b>015-073</b>

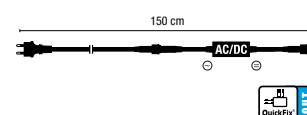

# STRING LITE® 120

Rubber 230 V



- QuickFix® Outdoor kompatibel
- kein Trafo notwendig
- hohe Leuchtkraft
- koppel- und erweiterbar
- Segmente austauschbar



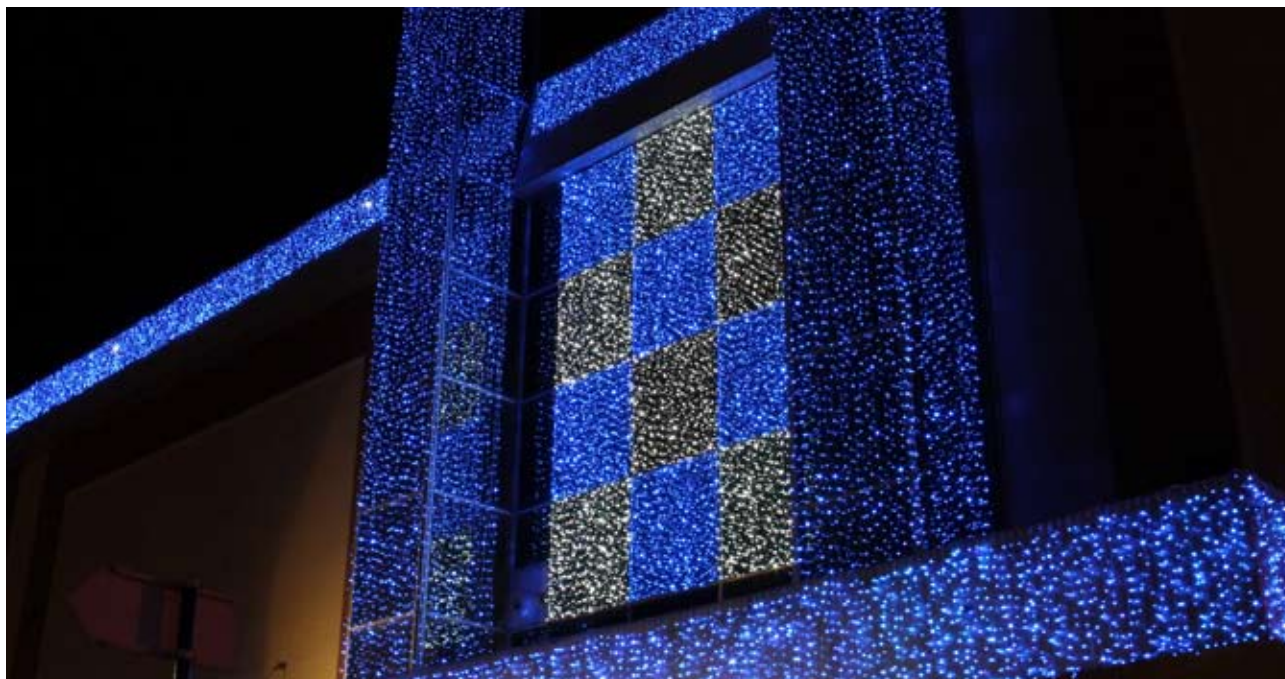

## LED STRING LITE® 120 – 20m

Länge: 20m  
 Anzahl der Segmente: 2  
 Lampen pro Segment: 60  
 Länge pro Segment: 10.00 m  
 220-240 V, 7 W, LED: 120  
**ohne Netzstecker**



- 018-360**  
LEDPLR-120-230VWH-BL
- 018-359**  
LEDPLR-120-230VSW-BL
- 018-363**  
LEDPLR-120-230VWH-RO
- 018-361**  
LEDPLR-120-230VSW-RO
- 018-362**  
LEDPLR-120-230VSW-AM
- 018-364**  
LEDPLR-120-230VSW-MC
- 018-365**  
LEDPLR-120-230VWH-GR

= rot, amber, grün, blau

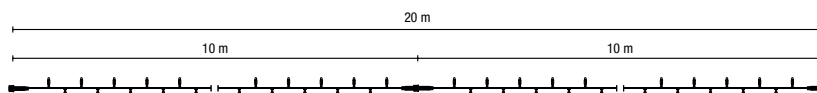

1 Kette = 2 Segmente á 10.0 m, max. 10 Ketten koppelbar

## LED QuickFix® Main Connector

Anschluss: Zuleitung an LED QuickFix®  
 mit Gleichrichter, max. Belastbarkeit: 480 W



	EU	UK	CH
	<b>014-418</b>	<b>015-070</b>	<b>015-071</b>
	<b>014-419</b>	<b>015-072</b>	<b>015-073</b>

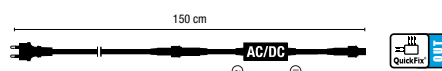

# STRING LITE® 120 – flashing

Rubber 230 V



Betrachten Sie den einzigartigen Effekt  
[www.mk-illumination.com/flash](http://www.mk-illumination.com/flash)



- QuickFix® Outdoor kompatibel
- kein Trafo notwendig
- hohe Leuchtkraft
- koppel- und erweiterbar
- Segmente austauschbar





## LED STRING LITE® 120 – 12m

Länge: 12m  
 Anzahl der Segmente: 3  
 Lampen pro Segment: 40  
 Blitz-LED pro Segment: 5  
 Länge pro Segment: 4.00 m  
 220-240 V, 10.5 W, LED: 120  
**ohne Netzstecker**



- NEW!** **018-367**  
LEDPLR-120-230VWH-WW-WWFL
- NEW!** **018-366**  
LEDPLR-120-230VSW-WW-WWFL
- 018-328**  
LEDPLR-120-230VWH-WW-WHFL
- 018-327**  
LEDPLR-120-230VSW-WW-WHFL
- 018-326**  
LEDPLR-120-230VWH-WH-WHFL
- 018-325**  
LEDPLR-120-230VSW-WH-WHFL

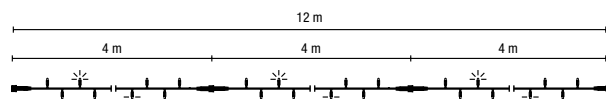

1 Kette = 3 Segmente á 4.0 m, max. 10 Ketten koppelbar

## LED QuickFix® Main Connector

Anschluss: Zuleitung an LED QuickFix®  
 mit Gleichrichter, max. Belastbarkeit: 480 W



	EU	UK	CH
	<b>014-418</b>	<b>015-070</b>	<b>015-071</b>
	<b>014-419</b>	<b>015-072</b>	<b>015-073</b>

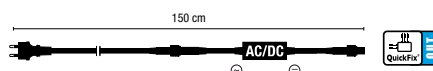

NEW!

# STRING LITE® 160 – flashing

Rubber 230 V



- QuickFix® Outdoor kompatibel
- kein Trafo notwendig
- hohe Leuchtkraft
- koppel- und erweiterbar
- Segmente austauschbar





**NEW!**

## LED STRING LITE® 160

Länge: 8m  
Anzahl der Segmente: 2  
Lampen pro Segment: 80  
Länge pro Segment: 4.00 m  
220-240 V, 14 W, LED: 160  
**ohne Netzstecker**



**018-408**  
LEDPLR-160-230VWH-WW

**018-368**  
LEDPLR-160-230VSW-WW

**018-409**  
LEDPLR-160-230VWH-WH

**018-369**  
LEDPLR-160-230VSW-WH

**018-410**  
LEDPLR-160-230VWH-BL

**018-411**  
LEDPLR-160-230VWH-RO

**018-412**  
LEDPLR-160-230VWH-GR

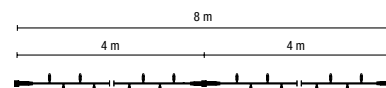

1 Kette = 2 Segmente à 4.0 m, max. 8 Ketten koppelbar



**NEW!**

## LED STRING LITE® 160

Länge: 8m  
Anzahl der Segmente: 2  
Lampen pro Segment: 80  
Blitz-LED pro Segment: 10  
Länge pro Segment: 4.00 m  
220-240 V, 14 W, LED: 160  
**ohne Netzstecker**



**018-402**  
LEDPLR-160-230VWH-WW-WWFL

**018-403**  
LEDPLR-160-230VWH-WH-WHFL

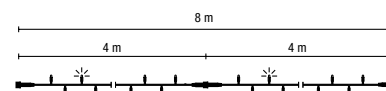

1 Kette = 2 Segmente à 4.0 m, max. 8 Ketten koppelbar

## LED QuickFix® Main Connector

Anschluss: Zuleitung an LED QuickFix®  
mit Gleichrichter, max. Belastbarkeit: 480 W



	EU	UK	CH
	<b>014-418</b>	<b>015-070</b>	<b>015-071</b>
	<b>014-419</b>	<b>015-072</b>	<b>015-073</b>

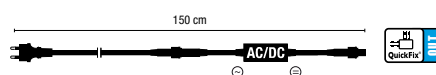

# STRING LITE®

E14 – Rubber 230 V



- traditionelle Lichterkette
- E14 Fassungen
- integrierter Dichtring
- geringer Stromverbrauch
- koppel- und erweiterbar





## LED STRING LITE® 20

Länge: 10m  
 Anzahl der Segmente: 1  
 Anzahl der Fassungen: 20  
 Länge pro Segment: 10.00 m  
 220-240 V,  
 ohne Leuchtmittel  
 ohne Netzstecker



**018-313**  
 LEDPLR-20-E14-230VSW

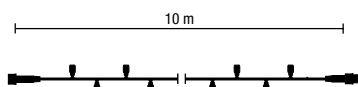

1 Kette = 1 Segmente á 10.0 m, max. 10 Ketten koppelbar

Es müssen alle Prisma Bulbs  
 ordnungsgemäß verschraubt werden.

## LED Prisma Bulb E14

12 V, 0.5 W, 0.5 VA

**014-450**  
 LED: 5

**014-445**  
 LED: 5

**014-446**  
 LED: 5

**014-447**  
 LED: 5

**014-448**  
 LED: 5

**014-449**  
 LED: 5



**015-022**  
 LED: 5

**015-023**  
 LED: 6



## QuickFix® Main Connector

Anschluss: Zuleitung an LED QuickFix®  
 mit Gleichrichter, max. Belastbarkeit: 480 W

	EU	UK	CH
	<b>014-233</b>	<b>015-066</b>	<b>015-067</b>
	<b>014-234</b>	<b>015-068</b>	<b>015-069</b>

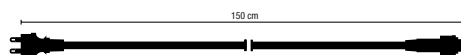

NEW!

# Magic STRING LITE®

Rubber 230 V



- QuickFix® Outdoor kompatibel
- kein Trafo notwendig
- hohe Leuchtkraft
- koppel- und erweiterbar



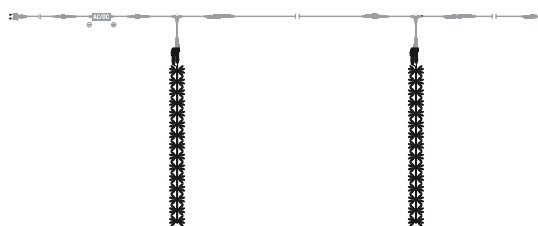

**NEW!**

**LED** MAGIC STRING LITE® 120

Länge: 2.5m  
Anzahl der Segmente: 1  
Lampen pro Segment: 120  
Länge pro Segment: 2.50 m  
220-240 V, 7 W, LED: 120  
**ohne Netzstecker**



 **LED 018-406**  
LEDMSLR-120-230VSW-WW

 **LED 018-407**  
LEDMSLR-120-230VSW-WH

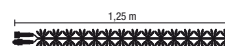

1 Kette = 1 Segmente à 2.5 m, max. 10 Ketten koppelbar



①



②

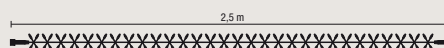

③

# Magic STRING LITE®

Rubber 230 V



- QuickFix® Outdoor kompatibel
- kein Trafo notwendig
- hohe Leuchtkraft
- koppel- und erweiterbar



**NEW!**

## LED MAGIC STRING LITE® 144

Länge: 6m  
Anzahl der Segmente: 1  
Lampen pro Segment: 144  
Länge pro Segment: 6.00 m  
220-240 V, 10.5 W, LED: 144  
ohne Netzstecker

**LED 018-404**  
LEDMSLR-144-230VSW-WW

**LED 018-405**  
LEDMSLR-144-230VSW-WH

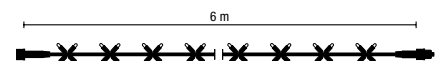

1 Kette = 1 Segmente à 6.0 m, max. 20 Ketten koppelbar

## LED QuickFix® Main Connector

Anschluss: Zuleitung an LED QuickFix®  
mit Gleichrichter, max. Belastbarkeit: 480 W

	EU	UK	CH
	<b>014-418</b>	<b>015-070</b>	<b>015-071</b>

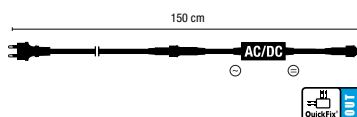

## LED QuickFix® Outdoor Adapter

Adapter: LED Gummiprodukte an QuickFix®  
mit Gleichrichter, max. Belastbarkeit: 480 W

**014-244**



# SWAG LITE®

Rubber 230 V



- QuickFix® Outdoor kompatibel
- kein Trafo notwendig
- hohe Leuchtkraft
- koppel- und erweiterbar
- biegsame Äste



## LED SWAG LITE® 360

Dimension: 2m x 0.45m x 0.45m  
 Anzahl der Segmente: 1  
 Lampen pro Segment: 360  
 Länge pro Segment: 2.00 m  
 220-240 V, 21 W, LED: 360



LED 018-314

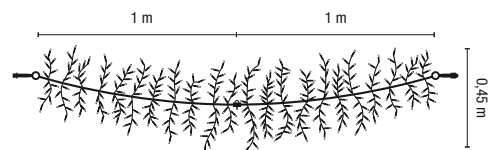

1 Kette = 1 Segmente à 2.0 m, max. 8 Ketten koppelbar

# DRAPE LITE®





*light impressions*

# DRAPE LITE®

Rubber 230 V



- QuickFix® Outdoor kompatibel
- kein Trafo notwendig
- hohe Leuchtkraft
- koppel- und erweiterbar
- Stränge austauschbar
- Stränge sind nicht QuickFix® kompatibel und nicht verlängerbar





### LED DRAPE LITE® 300

Dimension: 2m x 1.5m  
 Anzahl der Segmente: 20  
 Lampen pro Segment: 15  
 Länge pro Segment: 1.50 m  
 220-240 V, 35 W, LED: 300  
**2 Segmente = 1 Serie**  
**ohne Netzstecker**



**018-329**  
 LEDPLR-1520-230VWH-WW  
 014-467 Ersatzstrang 1.5 m

**018-330**  
 LEDPLR-1520-230VSW-WW  
 014-833 Ersatzstrang 1.5 m

**018-335**  
 LEDPLR-1520-230VWH-WH  
 014-412 Ersatzstrang 1.5 m

**018-373**  
 LEDPLR-1520-230VWH-BL  
 014-413 Ersatzstrang 1.5 m

**018-374**  
 LEDPLR-1520-230VWH-RO  
 014-834 Ersatzstrang 1.5 m

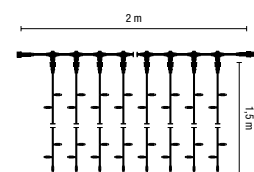

max. 10 Vorhänge koppelbar

### LED DRAPE LITE® 600

Dimension: 2m x 3m  
 Anzahl der Segmente: 20  
 Lampen pro Segment: 30  
 Länge pro Segment: 3.00 m  
 220-240 V, 35 W, LED: 600  
**2 Segmente = 1 Serie**  
**ohne Netzstecker**



**018-331**  
 LEDPLR-3020-230VWH-WW  
 014-468 Ersatzstrang 3.0 m

**018-332**  
 LEDPLR-3020-230VSW-WW  
 014-835 Ersatzstrang 3.0 m

**018-336**  
 LEDPLR-3020-230VWH-WH  
 014-414 Ersatzstrang 3.0 m

**018-378**  
 LEDPLR-3020-230VWH-BL  
 014-415 Ersatzstrang 3.0 m

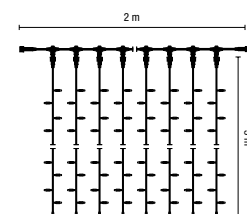

max. 7 Vorhänge koppelbar

### DRAPE LITE® Mounting Track

**014-855**  
 Länge: 2.08m

- ① Alu-Schiene
- ② Fixierungsstange mit Kabelbinder
- ③ Kunststoffbolzen

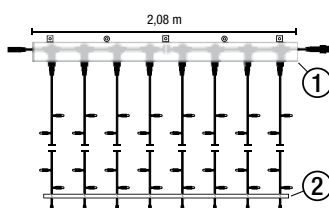

Nur für DRAPE LITE® geeignet!

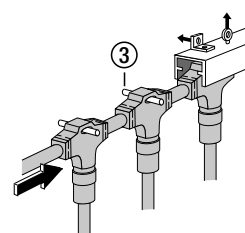

# DRAPE LITE®

Rubber 230 V



- QuickFix® Outdoor kompatibel
- kein Trafo notwendig
- hohe Leuchtkraft
- koppel- und erweiterbar
- Stränge austauschbar
- Stränge sind nicht QuickFix® kompatibel und nicht verlängerbar





## LED DRAPE LITE® 1200

Dimension: 2m x 6m  
 Anzahl der Segmente: 20  
 Lampen pro Segment: 60  
 Länge pro Segment: 6.00 m  
 220-240 V, 70 W, LED: 1200  
**1 Segment = 1 Serie**  
**ohne Netzstecker**



**LED 018-333**  
 LEDPLR-6020-230VWH-WW  
 014-469 Ersatzstrang 6.0 m

**LED 018-334**  
 LEDPLR-6020-230VSW-WW  
 014-836 Ersatzstrang 6.0 m

**LED 018-337**  
 LEDPLR-6020-230VWH-WH  
 014-470 Ersatzstrang 6.0 m

**LED 018-382**  
 LEDPLR-6020-230VWH-BL  
 014-471 Ersatzstrang 6.0 m

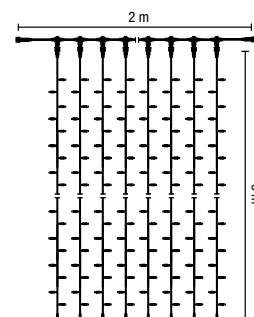

max. 3 Vorhänge koppelbar

## DRAPE LITE® Mounting Track

**014-855**  
 Länge: 2.08m

- ① Alu-Schiene
- ② Fixierungsstange mit Kabelbinder
- ③ Kunststoffbolzen

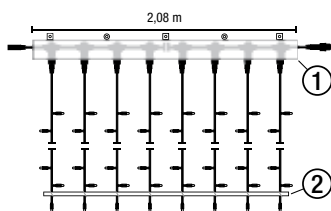

Nur für DRAPE LITE® geeignet!

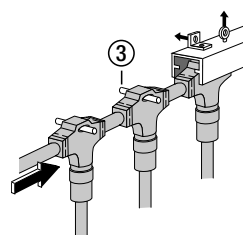

## LED QuickFix® Main Connector

Anschluss: Zuleitung an LED QuickFix®  
 mit Gleichrichter, max. Belastbarkeit: 480 W



	EU	UK	CH
	<b>014-418</b>	<b>015-070</b>	<b>015-071</b>
	<b>014-419</b>	<b>015-072</b>	<b>015-073</b>

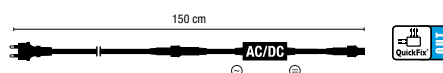

# DRAPE LITE® – flashing

Rubber 230 V



Betrachten Sie den einzigartigen Effekt  
[www.mk-illumination.com/flash](http://www.mk-illumination.com/flash)



- QuickFix® Outdoor kompatibel
- kein Trafo notwendig
- hohe Leuchtkraft
- koppel- und erweiterbar
- Stränge austauschbar
- Stränge sind nicht QuickFix® kompatibel und nicht verlängerbar





### LED DRAPE LITE® 300

Dimension: 2m x 1,5m  
 Anzahl der Segmente: 20  
 Lampen pro Segment: 15  
 Blitz-LED pro Segment: 2  
 Länge pro Segment: 1,50 m  
 220-240 V, 35 W, LED: 300  
**2 Segmente = 1 Serie  
 ohne Netzstecker**



**NEW!** **018-384**  
 LEDPLR-1520-230VWH-WW-WHFL  
 015-599 Ersatzstrang 1,5 m

**018-339**  
 LEDPLR-1520-230VWH-WW-WHFL  
 014-928 Ersatzstrang 1,5 m

**018-338**  
 LEDPLR-1520-230VWH-WH-WHFL  
 014-927 Ersatzstrang 1,5 m

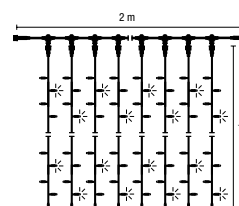

max. 10 Vorhänge koppelbar

### LED DRAPE LITE® 600

Dimension: 2m x 3m  
 Anzahl der Segmente: 20  
 Lampen pro Segment: 30  
 Blitz-LED pro Segment: 4  
 Länge pro Segment: 3,00 m  
 220-240 V, 35 W, LED: 600  
**2 Segmente = 1 Serie  
 ohne Netzstecker**



**NEW!** **018-385**  
 LEDPLR-3020-230VWH-WW-WHFL  
 015-600 Ersatzstrang 3,0 m

**018-341**  
 LEDPLR-3020-230VWH-WW-WHFL  
 014-930 Ersatzstrang 3,0 m

**018-340**  
 LEDPLR-3020-230VWH-WH-WHFL  
 014-929 Ersatzstrang 3,0 m

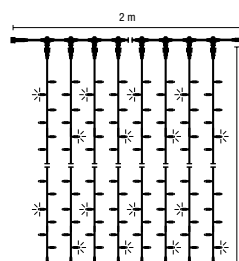

max. 7 Vorhänge koppelbar

### DRAPE LITE® Mounting Track

**014-855**  
 Länge: 2,08m

- ① Alu-Schiene
- ② Fixierungsstange mit Kabelbinder
- ③ Kunststoffbolzen

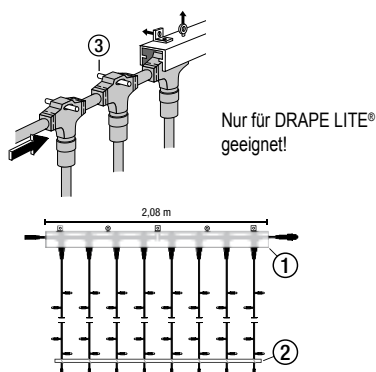

### LED QuickFix® Main Connector

Anschluss: Zuleitung an LED QuickFix®  
 mit Gleichrichter, max. Belastbarkeit: 480 W

EU	UK	CH	
<b>014-419</b>	<b>015-072</b>	<b>015-073</b>	



ICE LITE®





*light impressions*

# ICE LITE®

Rubber 230 V



- QuickFix® Outdoor kompatibel
- kein Trafo notwendig
- hohe Leuchtkraft
- koppel- und erweiterbar
- Segmente austauschbar





### LED ICE LITE® 114

Dimension: 3m x 0.5m  
 Anzahl der Segmente: 2  
 Lampen pro Segment: 57  
 Länge pro Segment: 1.50 m  
 220-240 V, 7 W, LED: 114  
**ohne Netzstecker**



-  **LED 018-342**  
LEDIPLR-57-50-114-230VWH-WW
-  **LED 018-343**  
LEDIPLR-57-50-114-230VSW-WW
-  **LED 018-348**  
LEDIPLR-57-50-114-230VWH-WH
-  **LED 018-390**  
LEDIPLR-57-50-114-230VWH-BL

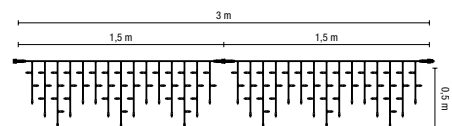



1 Kette = 2 Segmente á 1.5 m, max. 20 Ketten koppelbar

### LED ICE LITE® 174

Dimension: 3m x 0.9m  
 Anzahl der Segmente: 3  
 Lampen pro Segment: 58  
 Länge pro Segment: 1.00 m  
 220-240 V, 10.5 W, LED: 174  
**ohne Netzstecker**



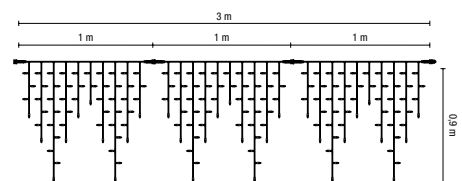

-  **LED 018-344**  
LEDIPLR-58-90-174-230VWH-WW
-  **LED 018-345**  
LEDIPLR-58-90-174-230VSW-WW
-  **LED 018-349**  
LEDIPLR-58-90-174-230VWH-WH



1 Kette = 3 Segmente á 1.0 m, max. 15 Ketten koppelbar

### LED QuickFix® Main Connector

Anschluss: Zuleitung an LED QuickFix®  
 mit Gleichrichter, max. Belastbarkeit: 480 W

	EU	UK	CH
	<b>014-418</b>	<b>015-070</b>	<b>015-071</b>
	<b>014-419</b>	<b>015-072</b>	<b>015-073</b>

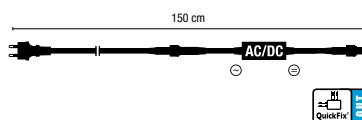

# GIANT ICE LITE®

Rubber 230 V



- QuickFix® Outdoor kompatibel
- kein Trafo notwendig
- hohe Leuchtkraft
- koppel- und erweiterbar
- Segmente austauschbar





## LED GIANT ICE LITE® 304

Dimension: 4m x 1.5m  
 Anzahl der Segmente: 4  
 Lampen pro Segment: 76  
 Länge pro Segment: 1.00 m  
 220-240 V, 14 W, LED: 304  
**ohne Netzstecker**



**LED 018-346**  
 LEDIPLR-76-150-304-230VWH-WW

**LED 018-347**  
 LEDIPLR-76-150-304-230VSW-WW

**NEW!** **LED 018-396**  
 LEDIPLR-76-150-304-230VWH-WH

**NEW!** **LED 018-397**  
 LEDIPLR-76-150-304-230VWH-BL

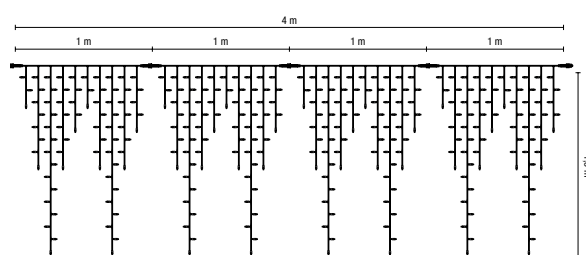

1 Kette = 4 Segmente à 1.0 m, max. 10 Ketten koppelbar

## LED QuickFix® Main Connector

Anschluss: Zuleitung an LED QuickFix®  
 mit Gleichrichter, max. Belastbarkeit: 480 W



	EU	UK	CH
	<b>014-418</b>	<b>015-070</b>	<b>015-071</b>
	<b>014-419</b>	<b>015-072</b>	<b>015-073</b>



# ICE LITE® – flashing

Rubber 230 V



Betrachten Sie den einzigartigen Effekt  
[www.mk-illumination.com/flash](http://www.mk-illumination.com/flash)



- QuickFix® Outdoor kompatibel
- kein Trafo notwendig
- hohe Leuchtkraft
- koppel- und erweiterbar
- Segmente austauschbar





### LED ICE LITE® 114

Dimension: 3m x 0.5m  
 Anzahl der Segmente: 2  
 Lampen pro Segment: 57  
 Blitz-LED pro Segment: 6  
 Länge pro Segment: 1.50 m  
 220-240 V, 7 W, LED: 114  
**ohne Netzstecker**



- NEW!**
- LED 018-398**  
LEDIPLR-57-50-114-230VWH-WW-WWFL
  - LED 018-352**  
LEDIPLR-57-50-114-230VWH-WW-WHFL
  - LED 018-353**  
LEDIPLR-57-50-114-230VWH-WH-WHFL

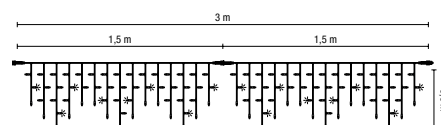

1 Kette = 2 Segmente á 1.5 m, max. 20 Ketten koppelbar

### LED ICE LITE® 174

Dimension: 3m x 0.9m  
 Anzahl der Segmente: 3  
 Lampen pro Segment: 58  
 Blitz-LED pro Segment: 8  
 Länge pro Segment: 1.00 m  
 220-240 V, 10.5 W, LED: 174  
**ohne Netzstecker**



- NEW!**
- LED 018-400**  
LEDIPLR-58-90-174-230VWH-WW-WWFL
  - LED 018-351**  
LEDIPLR-58-90-174-230VWH-WW-WHFL
  - LED 018-350**  
LEDIPLR-58-90-174-230VWH-WH-WHFL

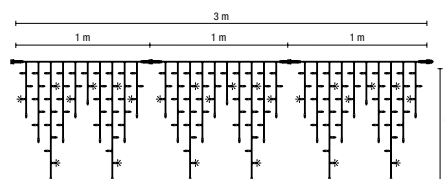

1 Kette = 3 Segmente á 1.0 m, max. 15 Ketten koppelbar

### LED QuickFix® Main Connector

Anschluss: Zuleitung an LED QuickFix®  
 mit Gleichrichter, max. Belastbarkeit: 480 W



# BRANCH LITE®

24 V



- hohe Leuchtkraft
- geringer Stromverbrauch
- 8 Lampen = 1 Serie
- nicht QuickFix® kompatibel



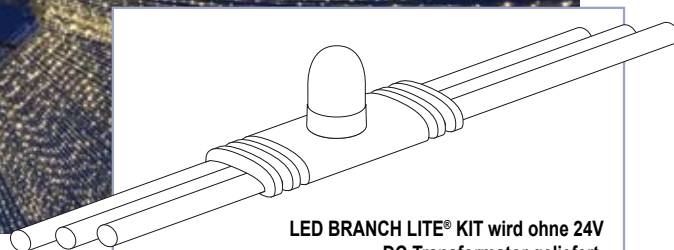

LED BRANCH LITE® KIT wird ohne 24V DC Transformator geliefert.

### LED BRANCH LITE® KIT

Dimension: 1m x 30m  
 Anzahl der Segmente: 4  
 Lampen pro Segment: 120  
 Länge pro Segment: 30.00 m  
 24 V, 30 W, LED: 480  
 Lampenabstand: 250mm  
 exkl. Transformator  
**ohne Netzstecker**



- 018-291**  
014-936 Accessory Pack
- 018-263**  
014-869 Accessory Pack
- 018-264**  
014-870 Accessory Pack

#### Accessory Pack

1 Strang mit 8 LED  
 1 Klebstoff  
 1 Endkappe  
 2 Verbinder  
 2 PE Schrumpfschläuche

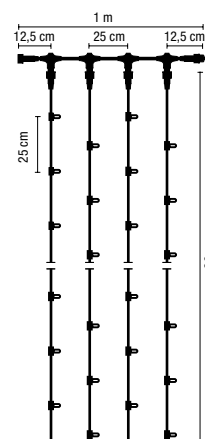

max. 4 Vorhänge koppelbar

### LED BRANCH LITE® Transformator 24V DC

PRI 230V / 50Hz, SEC 24V DC / 200VA, IP64, max. 4x LED BRANCH LITE® KIT (018-263, 018-264, 018-291)

**014-513**



### Adapter Branch Lite Transformer

**014-854**

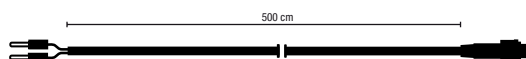

# CRYSTAL PARTY LITE®

E27 / 230 V



- traditionelle Lichterkette
- E27 Fassungen
- integrierter Dichtring
- mit Befestigungsvorrichtung





### CRYSTAL PARTY LITE® KIT 100

Gummifachbandkabel mit E27 Fassungen  
- vormontiert  
exkl. Lampen (max. 15W)  
Fassungen: 100  
Länge: 50m  
220-240 V, max. Belastbarkeit: 1500 W

**112-113**  
FLC-2x1.5-50-100



### CRYSTAL PARTY LITE® KIT 200

Gummifachbandkabel mit E27 Fassungen  
- vormontiert  
exkl. Lampen (max. 15W)  
Fassungen: 200  
Länge: 100m  
220-240 V, max. Belastbarkeit: 3000 W

**112-025**  
FLC-2x1.5-100-200



### CRYSTAL PARTY LITE® ACCESSORIES

Endhaken  
**014-033**



Netzstecker  
**014-032**



### FilaLED

#### LED FilaLED BALL E27

Tropfenformlampe, LED: 1, 220-240 V  
2.2 W, 2.4 VA

LED **015-024**

FROSTED LED **015-025**



#### LED FilaLED PEAR E27

Birnenformlampe, LED: 1, 220-240 V  
2.2 W, 2.4 VA

LED **015-026**

FROSTED LED **015-027**



### Golf Ball

#### LED GOLF BALL E27

LED Tropfenformlampe, LED: 12, 220-240 V  
1.5 W, 5 VA

FROSTED LED **014-106**

FROSTED LED **014-100**

FROSTED LED **014-101**

FROSTED LED **014-102**

FROSTED LED **014-103**

FROSTED LED **014-104**

FROSTED LED **014-105**

LED **014-107**



### Deco Golf Ball

#### LED DECO GOLF BALL E27

Tropfenformlampe, LED: 7, 220-240 V  
1 W, 5 VA

LED **015-078**

LED **015-079**

FROSTED LED **015-080**

FROSTED LED **015-081**



# ICE DROP®

230 V



Betrachten Sie die einzigartige Wirkung von  
ICE DROP®

[www.mk-illumination.com/icedrop](http://www.mk-illumination.com/icedrop)

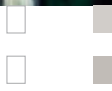

- QuickFix® Outdoor kompatibel
- kein Trafo notwendig
- hohe Leuchtkraft
- koppel- und erweiterbar
- 360° Grad Effekt





**LED ICE DROP® 64**

Dimension: Ø 10 x 75cm  
LED: 64  
220-240 V, 3.5 W  
ohne Netzstecker

**LED 018-274**



**LED ICE DROP® 96**

Dimension: Ø 11.2 x 115cm  
LED: 96  
220-240 V, 4 W  
ohne Netzstecker

**LED 018-278**

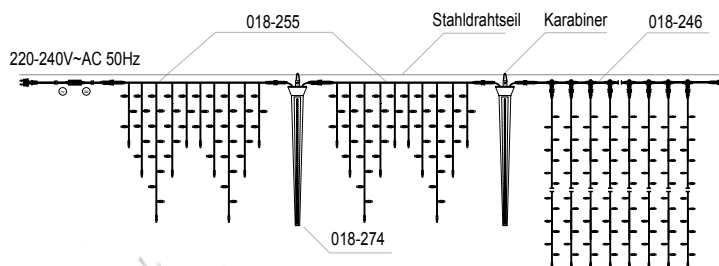

max. 50 Ketten koppelbar

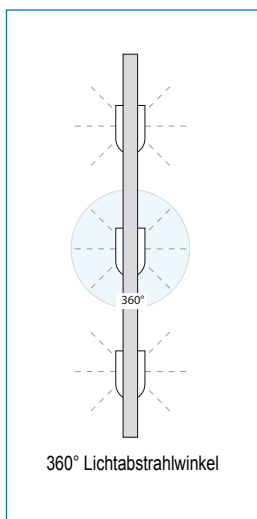
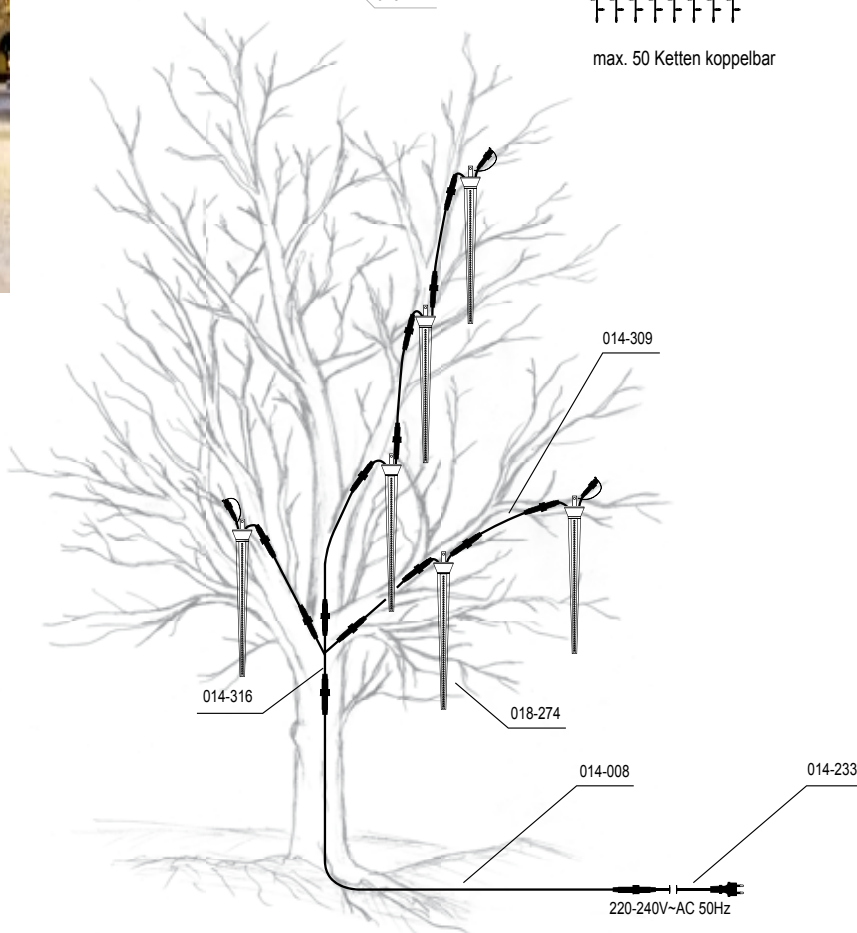



# Bulbs

## by MK ILLUMINATION

Alle Leuchtmittel der Professional Line sind am Stand der Technik und mit reinsten Lichtfarben.

Folgende Leuchtmittel sind erhältlich:

- FilaLED E27 / E14
- Golf Ball E27
- Deco Golf Ball E27
- Flash Light E27 / B22
- Prisma Bulb E14

professionelle Outdoor & Indoor Qualität  
LED Technologie am neuesten Stand



# MK BULBS



- professionelle Outdoor & Indoor Qualität
- einzigartiges Warmweiss
- FilaLED ist dimmbar
- Golf Ball und Deco Golf Ball sind nicht dimmbar
- 220-240 V AC

## FilaLED

### LED FilaLED BALL E27

Tropfenformlampe, LED: 1, 220-240 V AC, 2,2 W  
2,4 VA

LED 015-024



LED 015-025



### LED FilaLED PEAR E27

Birnenformlampe, LED: 1, 220-240 V AC, 2,2 W  
2,4 VA

LED 015-026



LED 015-027



### LED FilaLED CANDLE E14

Kerzenformlampe, LED: 1, 220-240 V AC, 2,2 W  
2,4 VA

LED 015-028



LED 015-029



## FilaLED

FilaLED E27 und E14, jetzt als Wechselstrom LED

Der Rolls Royce unter den LED-Leuchtmitteln. Der optimale Powerfactor von beinahe 1\* belegt die Spitzenqualität der neuesten LED-Technik. Mit nur 2,4 VA Energieverbrauch ist die FilaLED die effizienteste am Markt. Kein Vorschaltgerät und damit weniger Elektronik, wesentlich geringeren Verschleiß und damit höhere Lebensdauer. So hebt sie sich deutlich von Energiespar- und anderen LED-Lampen ab.

Der speziell geschliffene Kristall im Inneren der FilaLED simuliert die Optik eines Glühfadens perfekt und kommt so der herkömmlichen Glühbirne mit warmweißer Lichtfarbe am nächsten. Die FilaLED gibt's in Kerzen-, Kugel- und Birnenform, sowohl mit mattem als auch klarem Glas und ist als einzige dimmbar.

ca. 50-55 Lumen und 2,4 VA Stromverbrauch

Die FilaLED Candle E14 ist nur für den Innenbereich geeignet!

## Golf Ball

### LED GOLF BALL E27

Tropfenformlampe, LED: 12, 220-240 V AC, 1,5 W  
5 VA

014-106

014-100

014-101

014-102

014-103



014-104

014-105

014-107



## Golf Ball

Durch die spezielle Form besitzt der Golf Ball mehr Oberfläche als herkömmliche LED-Leuchtmittel und gibt daher auch mehr Licht ab und überzeugt durch ein herausragendes Preis-Leistungsverhältnis. Das Gehäuse besteht aus mattem oder klarem Polycarbonat, ist somit extrem widerstandsfähig und bruchsicher. Die neue konische Form des Sockels passt sich besonders gut dem Dichtungsring verschiedener, marktüblicher Fassungen an. Somit bestens für den Innen- sowie Außenbereich geeignet.

**ca. 25 Lumen**

nicht dimmbar

## Deco Golf Ball

### LED DECO GOLF BALL E27

Tropfenformlampe, LED: 7, 220-240 V AC, 1 W  
5 VA

015-078

015-080



015-079

015-081



## Deco Golf Ball

Der Deco Golf Ball ist mit seiner etwas geringeren Leuchtkraft und normalen Kugelform die günstigere Variante. Er schaut zwar der Kugelglühbirne am ähnlichsten hat allerdings nicht für alle unterschiedlichen marktüblichen Fassungen die optimale Passform. Der Deco Golf Ball ist mit warmweißer oder brillantweißer Lichtfarbe, mit mattem oder klarem Polycarbonatgehäuse erhältlich. Achtung: Bei Außenanwendung muss eine passende Fassung samt Silikon Dichttring verwendet werden.

**ca. 20 Lumen und 7 LED's**

nicht dimmbar

# MK BULBS



- professionelle Outdoor & Indoor Qualität
- einzigartiges Warmweiss
- 230V & 12V AC / nicht dimmbar

# Flash Light

## LED FLASH E27

Blitzrate 1-2 Blitze pro Sekunde  
LED: 10, 220-240 V, 1 W,  
Lebensdauer: min. 5000 Stunden

**LED** 014-261

**LED** 014-262

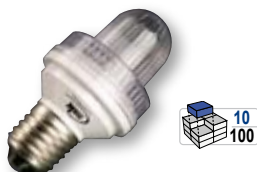

## LED FLASH B22

Blitzrate 1-2 Blitze pro Sekunde  
Sockel B22 (Aluminium), LED: 10, 220-240 V, 1 W  
Lebensdauer: min. 5000 Stunden

**LED** 014-266

**LED** 014-267

**LED** 014-268

**LED** 014-269

**LED** 014-270



Nur in Frankreich erhältlich!

## FLASH E27

Blitzrate 1-2 Blitze pro Sekunde  
220-240 V, 8 W  
Lebensdauer: 1-1,5 Mio. Flashes

014-062 014-065

014-063 014-066

014-064

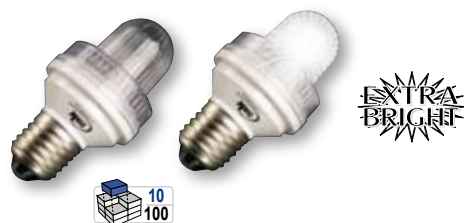

## FLASH B22

Blitzrate 1-2 Blitze pro Sekunde  
220-240 V, 24 W  
Lebensdauer: 1-1,5 Mio. Flashes

014-444

Nur in Frankreich erhältlich!

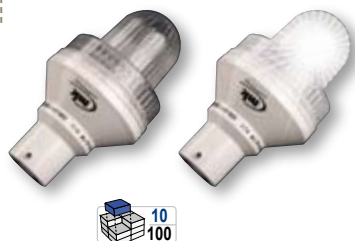

# Prisma Bulb

## LED Prisma Bulb E14 / 12V

12 V, 0,5 W, 0,5 VA

**LED** 014-450  
LED: 5

**LED** 014-445  
LED: 5

**LED** 014-446  
LED: 5

**LED** 014-447  
LED: 5

**LED** 014-449  
LED: 5

**LED** 014-448  
LED: 5

**LED** 015-022  
LED: 5

**LED** 015-023  
LED: 6



# Flash Light

Diese LEDs oder Strobes blinken in regelmäßigen Abständen kurz auf und simulieren so perfekte „Lichtblitze“, die gerne für Baum- und Fassadendekorationen verwendet werden. Selbstredend, dass damit jedes Motiv alle Aufmerksamkeit auf sich zieht.

# Prisma Bulb

Wird seit geraumer Zeit gerne als Ersatzleuchtmittel für herkömmliche Glühbirnen bei traditionellen E14 Motiven verwendet. Die Prisma-LED ist in verschiedenen Farben erhältlich und besticht durch das einzigartige Diamantschliff Polycarbonatgehäuse, das ein brillantes Licht entstehen lässt. Zusätzlich sind Prisma-LEDs als Flash-Lights und als RGB-Multicolor mit sanft fließendem Lichtwechsel erhältlich.



# QuickFix® Low Voltage

## 100% LED

**QuickFix® Low Voltage 36 V** – elegant, transparent und gleichzeitig die professionellste Niedervolt Lichterkette am Markt, mit Niedervolttransformator IP67 für den Außen- und Innenbereich. Die LEDs sind in die Polycarbonatkappen mittels Epoxydharz eingegossen und versiegelt. Das garantiert immer perfekten Kontakt und den sicheren Schutz gegen Nässe. Diese Bauweise in Verbindung mit dem Sicherheitsdrehverschluss gewährleistet nicht nur eine schnelle, leichte und sichere Montage, sondern auch die Schutzart IP44. Alle QuickFix® Low Voltage 36 V Lichterketten sind ausschließlich untereinander koppelbar. Ideal geeignet für Dekorationen im Handbereich oder wo Niedervolt vorgeschrieben wird.



- QuickFix® Low Voltage kompatibel
- Trafo erforderlich
- koppel- und erweiterbar
- transparentes Kabel
- Segmente austauschbar
- inklusive Endkappe

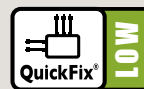

# PROFESSIONAL LOW VOLTAGE. GREEN ENERGY.LED.



## Verbindungsmethodik SYSTEM 80

Ein speziell entwickeltes Verbindungssystem für die neue professionelle Niedervolt Produktserie von MK Illumination. Die hier angewandten Parameter „einfach“, „schnell“ und „sicher“ wurden auch beim neuen QuickFix® Low Voltage System perfekt umgesetzt.

Da es sich um ein Niedervolt-System handelt, ist es wichtig, die folgenden Kriterien zu beachten:

1. die maximal koppelbare Länge der Dekorationsleitung = vom Trafo (inkl. QuickFix® Zubehör) maximal 80 Meter
2. die maximale Anzahl von LEDs einer Dekorationsleitung = maximal 5.500 LEDs
3. die maximale Belastung des QuickFix® Zubehörs = 200 W / 5.500 LEDs
4. die maximale Belastbarkeit des Trafos ist abhängig von der Trafoauswahl (15 W, 30 W, 60 W, 200 W, 400 W, 800 W)

Die folgenden Beispiele und Erklärungen machen Sie in Kürze zu einem Experten der professionellen Niedervoltbeleuchtung.

*Achtung: Das neue QuickFix® 36V System ist nicht koppelbar mit QuickFix® 230V!*

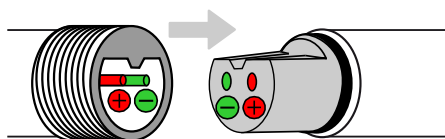

### VORTEILE

#### LED 36V OUTDOOR/INDOOR

Deutlich weniger CO<sub>2</sub> Emissionen durch energiesparende LED's und einen um 80 Prozent geringeren Stromverbrauch

Alle Produkte haben transparente Polycarbonatkappen und Sockelhüllen für einen brillanten 360 Grad Effekt

Die mit Epoxydharz versiegelten Polycarbonatkappen garantieren IP44 und schützen vor Schäden durch Zugbelastungen

Erhöhter UV Schutz durch Polycarbonatkappen, dadurch höhere Lebensdauer der LED

Einfache und schnelle Installation mit dem neu patentierten QuickFix® System 80

QuickFix® Trafo Anschlüsse verschiedener Leistungen, IP67 – Made in Germany



# SYSTEM 80

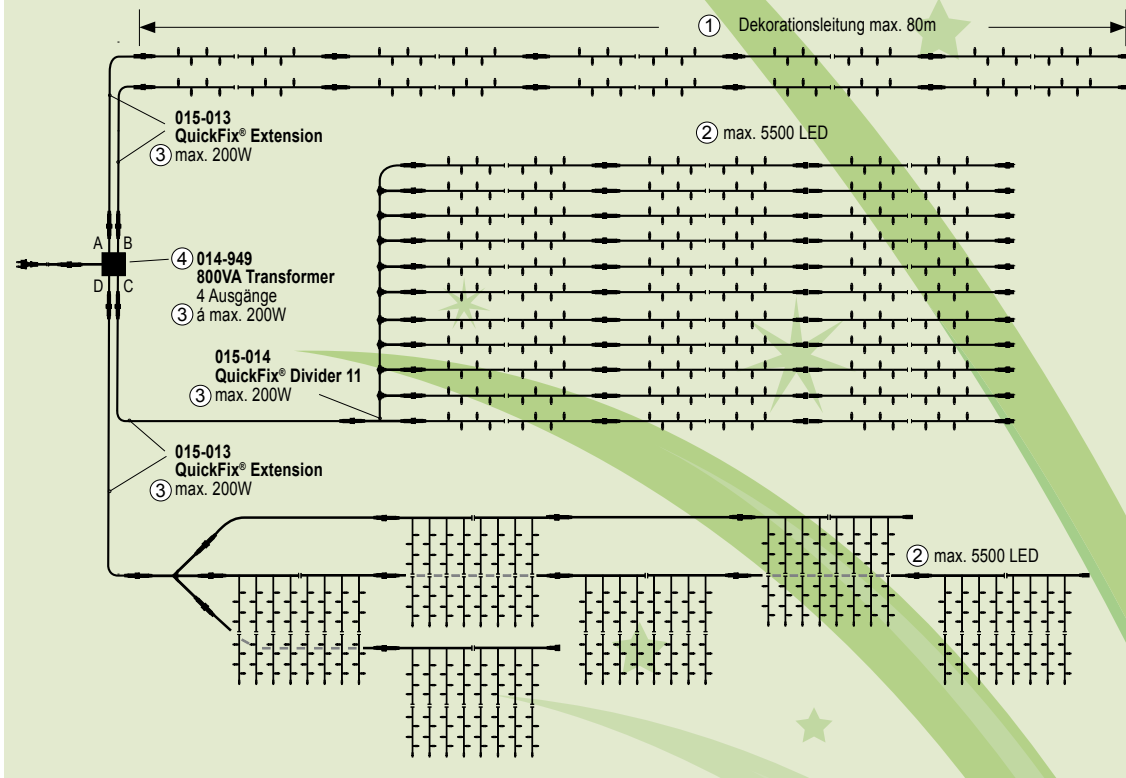

## Beispiel einer Installation

Bei dieser Installation wird ein 800VA Transformator mit vier Ausgängen verwendet. An diesen darf maximal 800W (4x200W) angeschlossen werden. Daraus resultiert die maximale Anzahl von 22.000 LED der Dekoration.

### Dekorationsleitung A:

6 String Lite 120	720 LED	72 m
2 Crystal String Lite 40	80 LED	8 m

Gesamt: 800 LED 80m

### Dekorationsleitung B:

6 String Lite 120	720 LED	72 m
2 Crystal String Lite 40	80 LED	8 m

Gesamt: 800 LED 80m

### Dekorationsleitung C: (11 Divider-Ausgänge)

4 String Lite 120	480 LED	48 m
pro Divider-Ausgang:	480 LED	48m

Gesamt: 5280 LED 48m

### Dekorationsleitung D:

2 Drape Lite 800	1600 LED	4 m
3 Drape Lite 800	2400 LED	6 m
1 Drape Lite 800	800 LED	2 m

Gesamt: 4800 LED 6m

A & B: jeweils eine Dekorationsleitung mit der maximalen Länge von 80m ①

C & D: Die Dekorationsleitung verbraucht weniger als 200W und unterschreitet die maximale Belastung des Verbinders, sowie die maximale Anzahl von 5500 LED. ② ③

Alle Ausgänge unterschreiten somit die maximale Anschlussleistung des Trafos von 800W. Mit nur einem verwendeten 800VA Trafo lässt sich eine Dekoration mit einer Gesamtzahl von 11680 LED umsetzen.

# POWER SUPPLIES

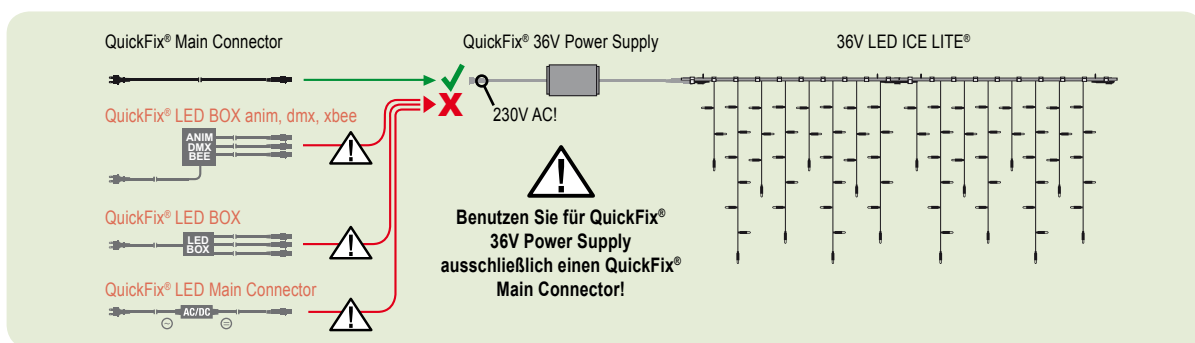

## QuickFix® Main Connector



Anschluss: Zuleitung an QuickFix®  
max. Belastbarkeit: 1800 W

	EU	UK	CH
	014-233	015-066	015-067
	014-234	015-068	015-069



## QuickFix® Extension 3



Verlängerungskabel 3m



014-013



## QuickFix® Extension 10



Verlängerungskabel 10m  
teilbar in 2 Segmente á 5m



014-008



### QuickFix® 36V Power Supply, 15 W (max 400 LED)

DC Transformator 15W, 1 Eingang, 1 Ausgang  
 PRI: 230V AC  
 SEC: 36V DC (0,42A)  
 162 x 35 x 23 mm  
 0,30 kg

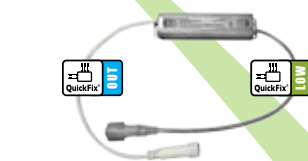
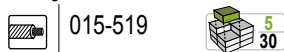

### QuickFix® 36V Power Supply, 30 W (max 800 LED)

DC Transformator 30W, 1 Eingang, 1 Ausgang  
 PRI: 230V AC  
 SEC: 36V DC (0,83A)  
 107 x 85 x 25 mm  
 0,45 kg

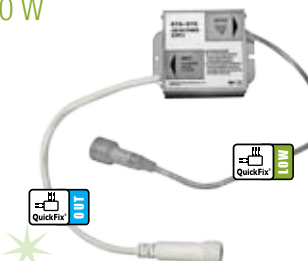
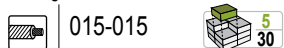

### **NEW!** QuickFix® 36V Power Supply, 60 W (max 1.600 LED)

DC Transformator 60W, 1 Eingang, 1 Ausgang  
 PRI: 230V AC  
 SEC: 36V DC (1,67A)  
 134 x 87 x 75 mm  
 0,75 kg

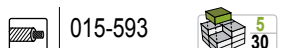

### QuickFix® 36V Power Supply, 200 W (max 5.500 LED)

DC Transformator 200W, 1 Eingang, 1 Ausgang  
 PRI: 230V AC (1,2A)  
 SEC: 36V DC (5,56A)  
 172 x 110 x 110 mm  
 4,1 kg



### QuickFix® 36V Power Supply, 400 W (max 11.000 LED)

DC Transformator 400W, 1 Eingang, 2 Ausgänge  
 PRI: 230V AC (2,4A)  
 SEC: 36V DC (11,1A)  
 172 x 110 x 159 mm  
 6,9 kg

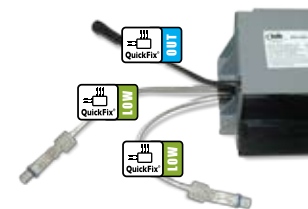
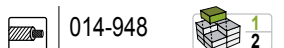

### QuickFix® 36V Power Supply, 800 W (max 22.000 LED)

DC Transformator 800W, 1 Eingang, 4 Ausgänge  
 PRI: 230V AC (4,8A)  
 SEC: 36V DC (22,2A)  
 240 x 173 x 153 mm  
 21,8 kg

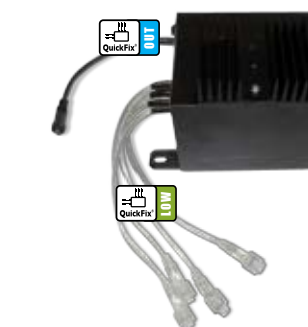
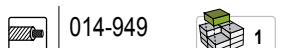

# ACCESSORIES LOW VOLTAGE

Power Supply, Divider, Extension

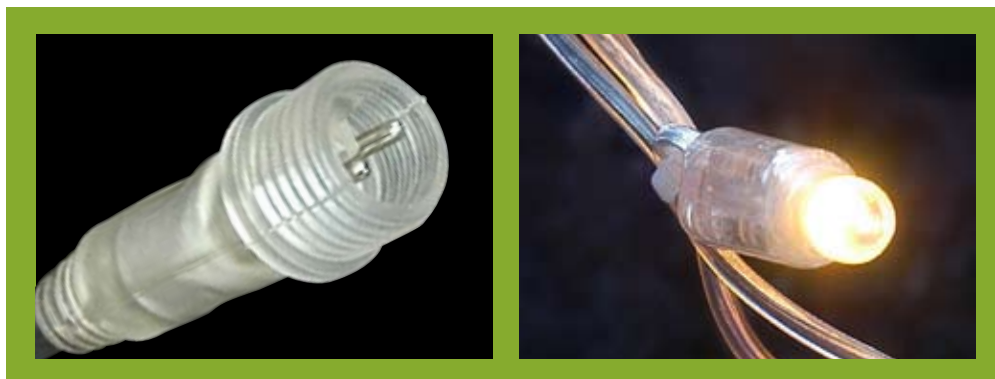
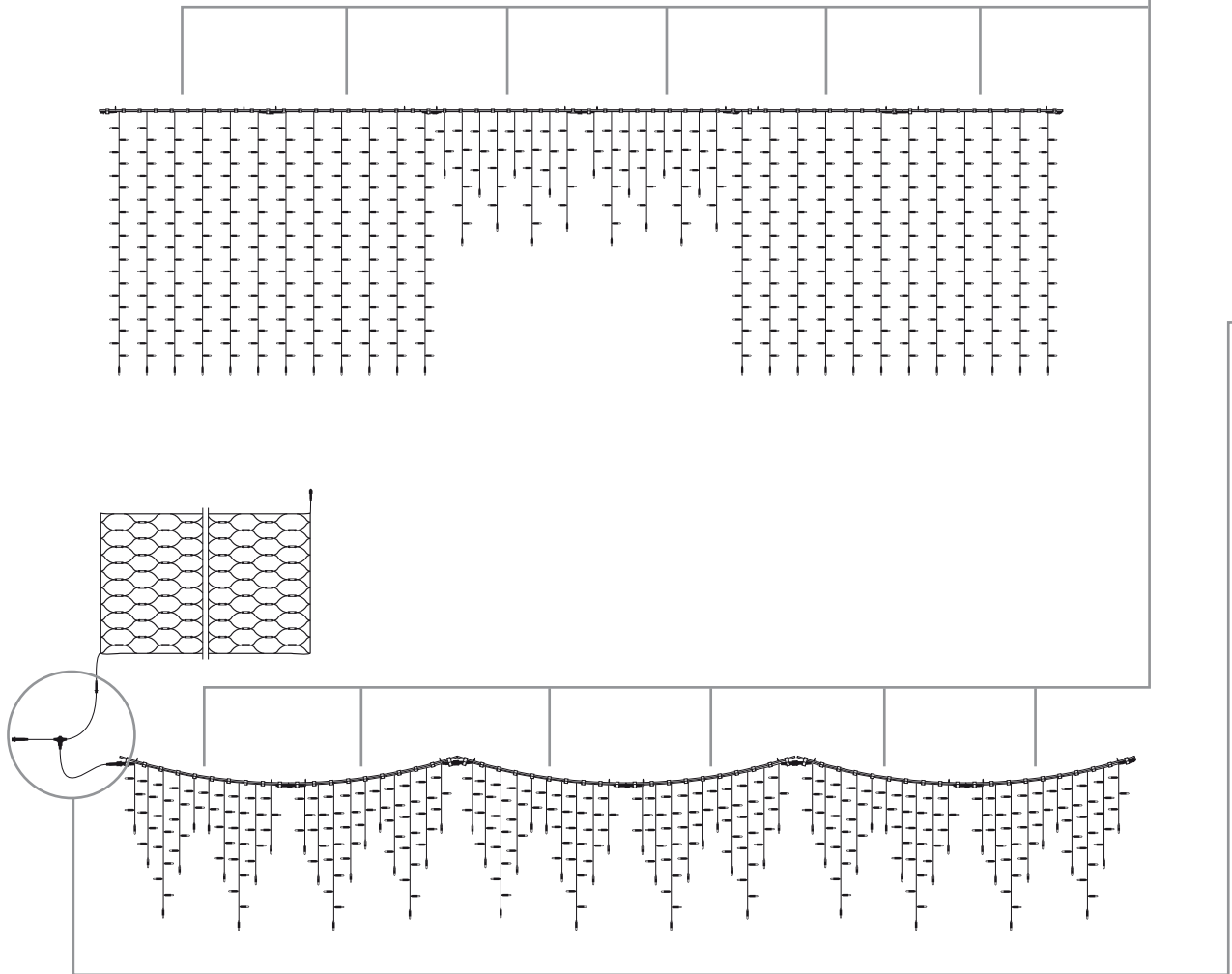

## Mounting Stick

015-019

Länge: 1m

- ① plastifizierter Flachstahl, formbar
- ② Klettverschluss
- ③ Befestigungspunkte

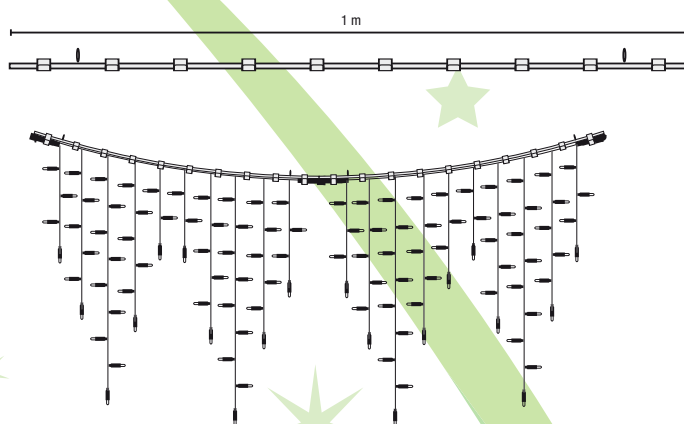
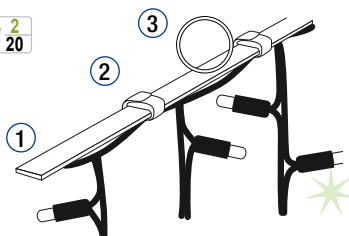

## QuickFix® Divider 2

T-Verbinder, Verteilerkabel mit 2 Ausgängen  
max. Belastbarkeit: 200 W



015-010



015-084

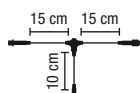

transparentes  
Kabel

## QuickFix® Divider 3

Verteilerkabel mit 3 Ausgängen  
max. Belastbarkeit: 200 W



015-011



015-085

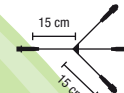

## QuickFix® Divider 11

Verteilerkabel mit 11 Ausgängen  
max. Belastbarkeit: 200 W



015-014

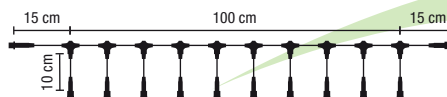

transparentes  
Kabel

## QuickFix® Extension 1

max. Belastbarkeit: 200 W



015-012



015-082

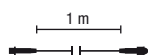

transparentes  
Kabel

## QuickFix® Extension 5

max. Belastbarkeit: 200 W



015-013



015-083



## QuickFix® Accessories

3 Endkappen,  
3 O-Ringe,  
3 Schrumpfschläuche



015-032



# STRING LITE®

Transparent PVC 36 V



- QuickFix® Low Voltage kompatibel
- koppel- und erweiterbar
- transparentes Kabel
- Segmente austauschbar





### 36V LED STRING LITE® 120 – 12m

Länge: 12m  
 Anzahl der Segmente: 3  
 Lampen pro Segment: 40  
 Länge pro Segment: 4.00 m  
 36 V, 4.3 W, LED: 120



**LED** 028-002  
 LEDPL-120-36VTR-WW

**LED** 028-001  
 LEDPL-120-36VTR-WH

transparentes  
Kabel

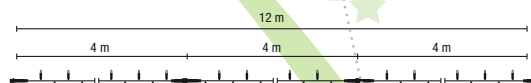
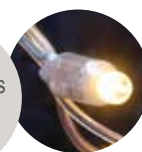

koppel- und erweiterbar – siehe Seite 77

### 36V LED STRING LITE® 120 – 20m

Länge: 20m  
 Anzahl der Segmente: 2  
 Lampen pro Segment: 60  
 Länge pro Segment: 10.00 m  
 36 V, 4.3 W, LED: 120



**LED** 028-019  
 LEDPL-120-36VGR-WW

**LED** 028-024  
 LEDPL-36VGR-WH

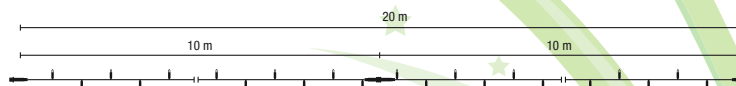

koppel- und erweiterbar – siehe Seite 77

### 36V LED CRYSTAL LITE® 40

Länge: 4m  
 Anzahl der Segmente: 1  
 Lampen pro Segment: 40  
 Länge pro Segment: 4.00 m  
 36 V, 1.5 W, LED: 40



**LED** 028-021  
 LEDPL-40-36VTR-WW

**LED** 028-022  
 LEDPL-40-36VTR-WH

transparentes  
Kabel

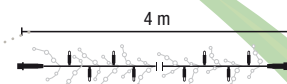

koppel- und erweiterbar – siehe Seite 77

# STRING LITE® – flashing

Transparent PVC 36 V



Betrachten Sie den einzigartigen Effekt  
[www.mk-illumination.com/flash](http://www.mk-illumination.com/flash)



- QuickFix® Low Voltage kompatibel
- koppel- und erweiterbar
- transparentes Kabel
- Segmente austauschbar





**NEW!**

### 36V LED STRING LITE® 120–12m

Länge: 12m  
 Anzahl der Segmente: 3  
 Lampen pro Segment: 40  
 Blitz-LED pro Segment: 5  
 Länge pro Segment: 4.00 m  
 36 V, 4.3 W, LED: 120



- 028-048**  
 LEDPL-120-36VTR-WW-WHFL
- 028-050**  
 LEDPL-120-36VSW-WW-WHFL
- 028-049**  
 LEDPL-120-36VTR-WH-WHFL



transparentes Kabel

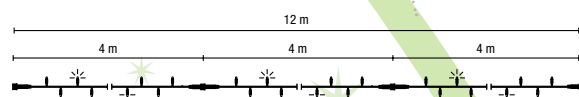

koppel- und erweiterbar – siehe Seite 77

### 36V LED CRYSTAL LITE® 40

Länge: 4m  
 Anzahl der Segmente: 1  
 Lampen pro Segment: 40  
 Blitz-LED pro Segment: 5  
 Länge pro Segment: 4.00 m  
 36 V, 1.5 W, LED: 40



- 028-039**  
 LEDPL-40-36VTR-WW-WHFL
- 028-040**  
 LEDPL-40-36VTR-WH-WHFL

transparentes Kabel

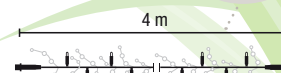

koppel- und erweiterbar – siehe Seite 77

NEW!

# FIREWORK

Transparent PVC 36 V



- QuickFix® Low Voltage kompatibel
- koppel- und erweiterbar
- transparentes Kabel





**NEW!**

**36V LED FIREWORK 160**

Länge: 1m  
Anzahl der Segmente: 1  
Lampen pro Segment: 160  
Länge pro Segment: 1.00 m  
36 V, 5.8 W, LED: 160



 **LED** 028-064  
LEDPL-160-36VTR-WW

 **LED** 028-065  
LEDPL-160-36VTR-WH

transparentes  
Kabel

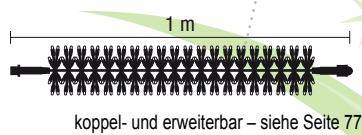

# DRAPE LITE®

Transparent PVC 36 V



- QuickFix® Low Voltage kompatibel
- koppel- und erweiterbar
- transparentes Kabel
- Segmente austauschbar





### 36V LED DRAPE LITE® 200

Dimension: 2m x 1.5m  
 Anzahl der Segmente: 20  
 Lampen pro Segment: 10  
 Länge pro Segment: 1.50 m  
 36 V, 7.1 W, LED: 200



3

**LED 028-004**  
 LEDPL-1020-36VTR-WW

**LED 028-003**  
 LEDPL-1020-36VTR-WH



transparentes  
Kabel

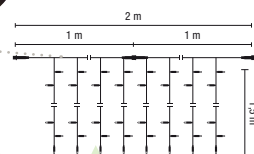

koppel- und erweiterbar – siehe Seite 77

### 36V LED DRAPE LITE® 400

Dimension: 2m x 3m  
 Anzahl der Segmente: 20  
 Lampen pro Segment: 20  
 Länge pro Segment: 3.00 m  
 36 V, 14.2 W, LED: 400



2

**LED 028-067**  
 LEDPL-2020-36VTR-WW

**LED 028-068**  
 LEDPL-2020-36VTR-WH



transparentes  
Kabel

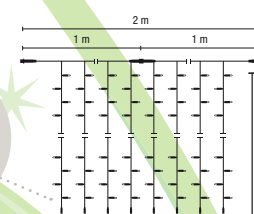

koppel- und erweiterbar – siehe Seite 77

### 36V LED DRAPE LITE® 800

Dimension: 2m x 6m  
 Anzahl der Segmente: 20  
 Lampen pro Segment: 40  
 Länge pro Segment: 6.00 m  
 36 V, 28.4 W, LED: 800



1

**LED 028-069**  
 LEDPL-4020-36VTR-WW

**LED 028-070**  
 LEDPL-4020-36VTR-WH



transparentes  
Kabel

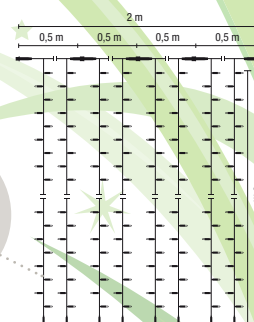

koppel- und erweiterbar – siehe Seite 77

### Mounting Stick

015-019  
 Länge: 1m

- ① plastifizierter Flachstahl, formbar
- ② Klettverschluss
- ③ Befestigungspunkte



20

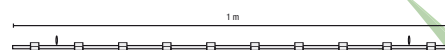
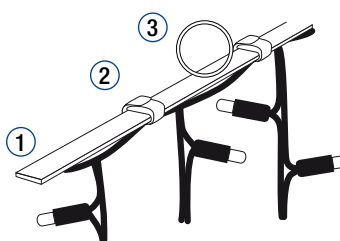

NEW!

# DRAPE LITE® – flashing

Transparent PVC 36 V



- QuickFix® Low Voltage kompatibel
- koppel- und erweiterbar
- transparentes Kabel
- Segmente austauschbar





**NEW!**

### 36V LED DRAPE LITE® 200

Dimension: 2m x 1.5m  
Anzahl der Segmente: 20  
Lampen pro Segment: 10  
Blitz-LED pro Segment: 1  
Länge pro Segment: 1.50 m  
36 V, 7.1 W, LED: 200

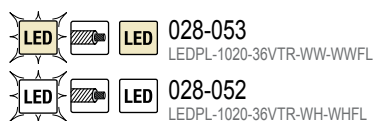

transparentes  
Kabel

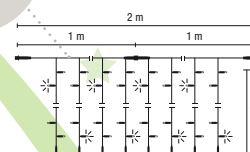
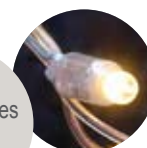

koppel- und erweiterbar – siehe Seite 77

### Mounting Stick

015-019

Länge: 1m

- ① plastifizierter Flachstahl, formbar
- ② Klettverschluss
- ③ Befestigungspunkte

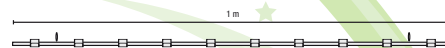
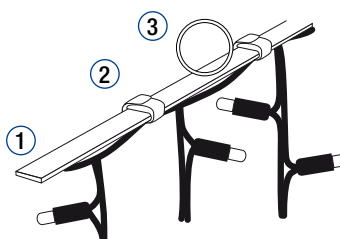

# ICE LITE® & GIANT ICE LITE®

Transparent PVC 36 V



- QuickFix® Low Voltage kompatibel
- koppel- und erweiterbar
- transparentes Kabel
- Segmente austauschbar





### 36V LED ICE LITE® 120

Dimension: 2m x 0.9m  
 Anzahl der Segmente: 2  
 Lampen pro Segment: 60  
 Länge pro Segment: 1.00 m  
 36 V, 4.3 W, LED: 120



-  **LED** 028-010  
LEDIPL-60-90-120-36VTR-WW
-  **LED** 028-009  
LEDIPL-60-90-120-36VTR-WH

transparentes  
Kabel

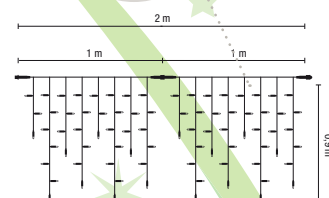
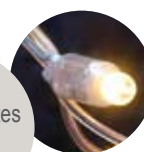

koppel- und erweiterbar – siehe Seite 77

NEW!

### 36V LED GIANT ICE LITE® 240

Dimension: 4m x 1.5m  
 Anzahl der Segmente: 4  
 Lampen pro Segment: 60  
 Länge pro Segment: 1.00 m  
 36 V, 8.8 W, LED: 240



-  **LED** 028-058  
LEDIPL-60-150-240-36VTR-WW
-  **LED** 028-059  
LEDIPL-60-150-240-36VTR-WH

transparentes  
Kabel

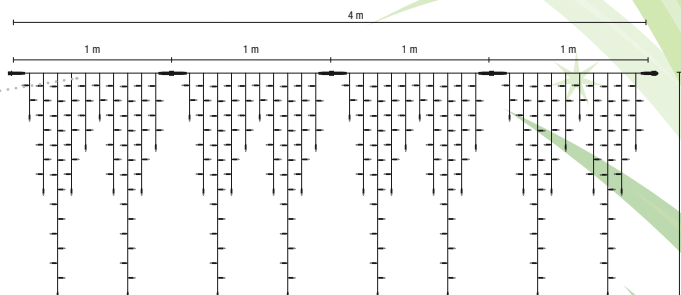

koppel- und erweiterbar – siehe Seite 77

NEW!

# ICE LITE® & GIANT ICE LITE® – flashing

Transparent PVC 36 V



- QuickFix® Low Voltage kompatibel
- koppel- und erweiterbar
- transparentes Kabel
- Segmente austauschbar









**NEW!**

### 36V LED ICE LITE® 120

Dimension: 2m x 0.9m  
Anzahl der Segmente: 2  
Lampen pro Segment: 60  
Blitz-LED pro Segment: 6  
Länge pro Segment: 1.00 m  
36 V, 4.3 W, LED: 120



-   **028-057**  
LEDIPL-60-90-120-36VVTR-WW-WWFL
-   **028-056**  
LEDIPL-60-90-120-36VVTR-WH-WHFL

transparentes  
Kabel

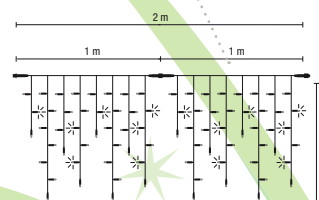
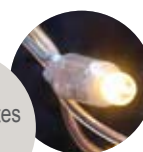

koppel- und erweiterbar – siehe Seite 77

**NEW!**

### 36V LED GIANT ICE LITE® 240

Dimension: 4m x 1.5m  
Anzahl der Segmente: 4  
Lampen pro Segment: 60  
Blitz-LED pro Segment: 6  
Länge pro Segment: 1.00 m  
36 V, 8.8 W, LED: 240



-   **028-061**  
LEDIPL-60-150-240-36VTR-WW-WWFL
-   **028-060**  
LEDIPL-60-150-240-36VTR-WH-WHFL

transparentes  
Kabel

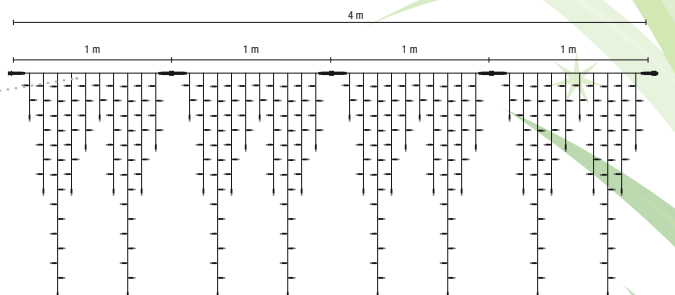

koppel- und erweiterbar – siehe Seite 77

# MESH LITE®

Transparent PVC 36 V



- QuickFix® Low Voltage kompatibel
- koppel- und erweiterbar
- transparentes Kabel



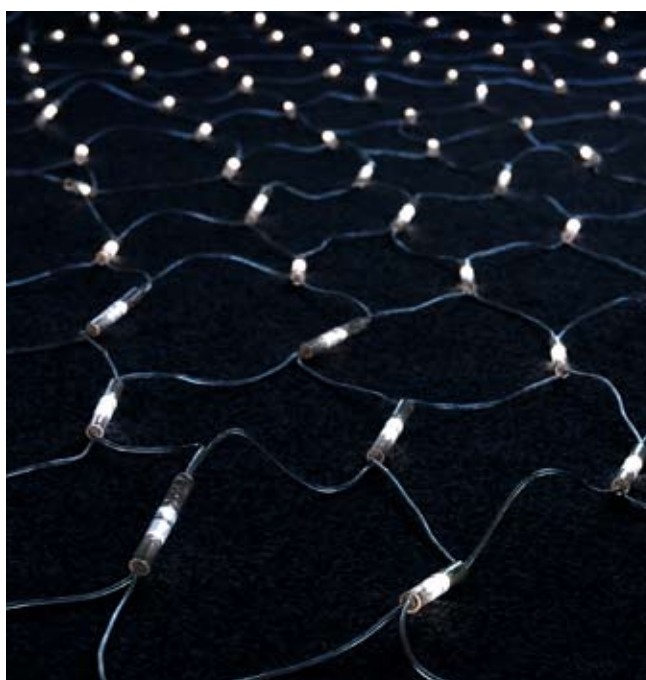

### 36V LED MESH LITE® 96

Dimension: 2m x 1m  
 Anzahl der Segmente: 1  
 Lampen pro Segment: 96  
 Länge pro Segment: 2.00 m  
 36 V, 3.5 W, LED: 96



- LED 028-011**  
LEDML-96-36VTR-WH
- LED 028-012**  
LEDML-96-36VTR-WW

transparentes  
Kabel

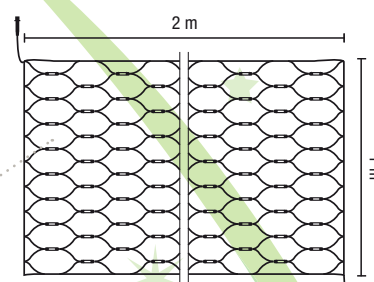

koppel- und erweiterbar – siehe Seite 77

### 36V LED MESH LITE® 200

Dimension: 4m x 2m  
 Anzahl der Segmente: 1  
 Lampen pro Segment: 200  
 Länge pro Segment: 4.00 m  
 36 V, 7.1 W, LED: 200



- LED 028-013**  
LEDML-200-36VTR-WH
- LED 028-014**  
LEDML-200-36VTR-WW

transparentes  
Kabel

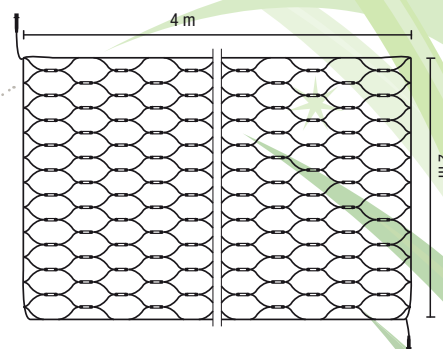
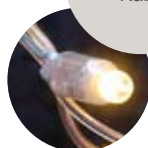

koppel- und erweiterbar – siehe Seite 77



# QuickFix® Indoor 100% LED

**QuickFix® Indoor 230 V** – die eleganten, transparenten PVC Lichterketten sind die sichersten Indoorketten am Markt weil die LEDs in die Polycarbonatkappen mittels Epoxydharz eingegossen und versiegelt sind. Die Kabel können somit nicht mehr aus der Fassung gezogen werden, ein dauerhaft perfekter Kontakt ist damit garantiert. Diese Bauweise in Verbindung mit dem Sicherheitsdrehverschluss gewährleistet eine schnelle, leichte und sichere Montage. Alle QuickFix® Indoor-Lichterketten 230 V sind ausschließlich untereinander koppelbar. Bestens geeignet für Christbäume, Girlanden, Kränze und allen Lichtideen für den Innenbereich.



QuickFix® Indoor kompatibel  
kein Trafo notwendig  
koppel- und erweiterbar  
Segmente austauschbar  
inklusive Endkappe

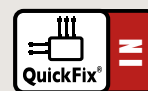

# QuickFix®

PVC 230 V



- Main Connector Indoor – transparent
- LED Box
- Extension Indoor
- Divider Indoor



### LED QuickFix® Main Connector Indoor

220-240 V  
max. Belastbarkeit: 480 W

	EU	UK	CH
	014-937	015-064	015-065
	015-618		

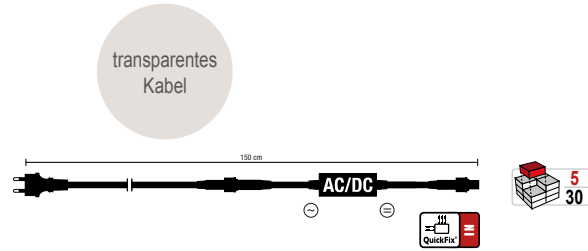

### QuickFix® Main Connector Indoor

220-240 V  
max. Belastbarkeit: 1500 W

	014-514	
	014-515	

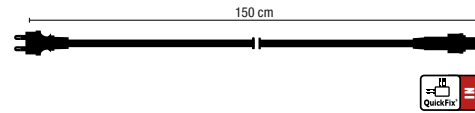

### QuickFix® Extension Indoor

Verlängerungskabel 3m  
220-240 V, max. Belastbarkeit: 1500 W

	015-075	
	014-454	
	014-455	

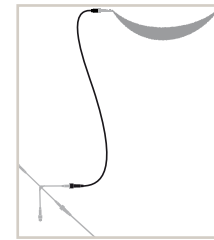
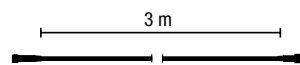

### QuickFix® T-Connector Indoor

T-Verbinder, Verbinderkabel mit 2 Ausgängen  
220-240 V, max. Belastbarkeit: 1500 W

	015-076	
	014-452	
	014-453	

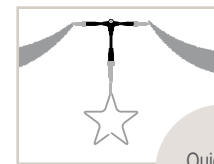
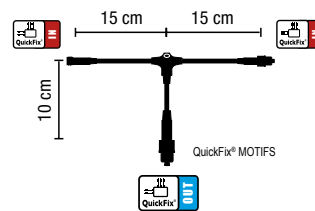

QuickFix®  
Collection

### QuickFix® LED-Box 3 Indoor

Verteilerdose zum Anschließen von QuickFix® LED Produkten, IP44, mit eingebauter Überlastsicherung  
Summe aller Ausgänge darf 1500W nicht überschreiten  
max. Belastbarkeit pro Ausgang: 1500W  
Zuleitung: QuickFix® Indoor Stecker  
220-240 V

	015-077	
--	---------	--

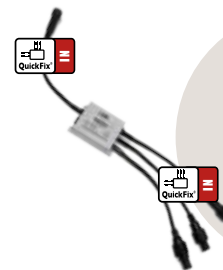

QuickFix® Main  
Connector Indoor  
014-514  
+  
QuickFix® LED-Box 3  
Indoor 015-077

### QuickFix® Divider 12

Verteilerkabel mit 12 Ausgängen  
220-240 V, max. Belastbarkeit: 1500 W

	014-938	
--	---------	--

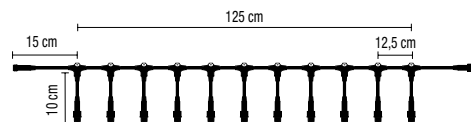

transparentes  
Kabel

### QuickFix® Divider 3

Verteilerkabel mit 3 Ausgängen  
220-240 V, max. Belastbarkeit: 1500 W

	015-074	
--	---------	--

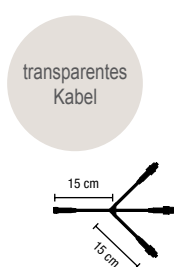

transparentes  
Kabel

### QuickFix® Accessories

- 3 Endkappen,
- 3 O-Ringe,
- 3 Schrumpfschläuche

	015-032	
--	---------	--



# STRING LITE®

PVC 230 V



- QuickFix® Indoor kompatibel
- kein Trafo notwendig
- koppel- und erweiterbar
- Segmente austauschbar





### LED STRING LITE® 120 – 12m

Länge: 12m  
 Anzahl der Segmente: 3  
 Lampen pro Segment: 40  
 Länge pro Segment: 4.00 m  
 220-240 V, 10.5 W, LED: 120

ohne Netzstecker



**LED 017-041**  
 LEDPL-120-230VGR-WW

**LED 017-042**  
 LEDPL-120-230VTR-WW

transparentes  
Kabel

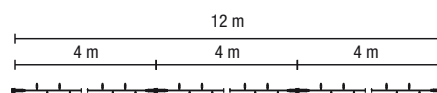

1 Kette = 3 Segmente á 4.0 m, max. 10 Ketten koppelbar

### LED STRING LITE® 120 – 20m

Länge: 20m  
 Anzahl der Segmente: 2  
 Lampen pro Segment: 60  
 Länge pro Segment: 10.00 m  
 220-240 V, 7 W, LED: 120

ohne Netzstecker



**LED 017-043**  
 LEDPL-120-230VGR-WW

**LED 017-044**  
 LEDPL-120-230VTR-WW

**LED 017-045**  
 LEDPL-120-230VTR-WH



transparentes  
Kabel

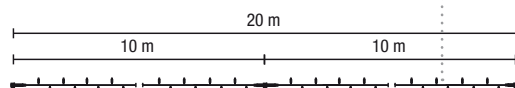

1 Kette = 2 Segmente á 10.0 m, max. 10 Ketten koppelbar

### LED QuickFix® Main Connector Indoor

220-240 V  
 max. Belastbarkeit: 480 W

	EU	UK	CH
	014-937	015-064	015-065
	015-618		



transparentes  
Kabel

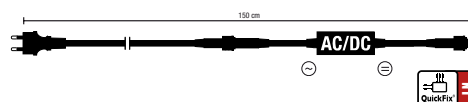

NEW!

# STRING LITE® – flashing

PVC 230 V



Betrachten Sie den einzigartigen Effekt  
[www.mk-illumination.com/flash](http://www.mk-illumination.com/flash)



- QuickFix® Indoor kompatibel
- kein Trafo notwendig
- koppel- und erweiterbar
- Segmente austauschbar





## LED STRING LITE® 120 – 12m

Länge: 12m  
 Anzahl der Segmente: 3  
 Lampen pro Segment: 40  
 Blitz-LED pro Segment: 5  
 Länge pro Segment: 4.00 m  
 220-240 V, 10.5 W, LED: 120  
**ohne Netzstecker**



**NEW!** **LED 017-050**  
 LEDPL-120-230VGR-WW-WWFL

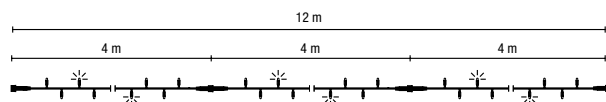

1 Kette = 3 Segmente à 4.0 m, max. 10 Ketten koppelbar

## LED QuickFix® Main Connector Indoor

220-240 V  
 max. Belastbarkeit: 480 W

	EU	UK	CH
	014-937	015-064	015-065
	015-618		



transparentes  
Kabel

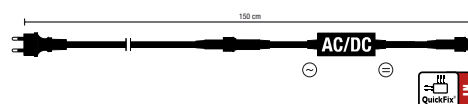

# DRAPE LITE®

PVC 230 V

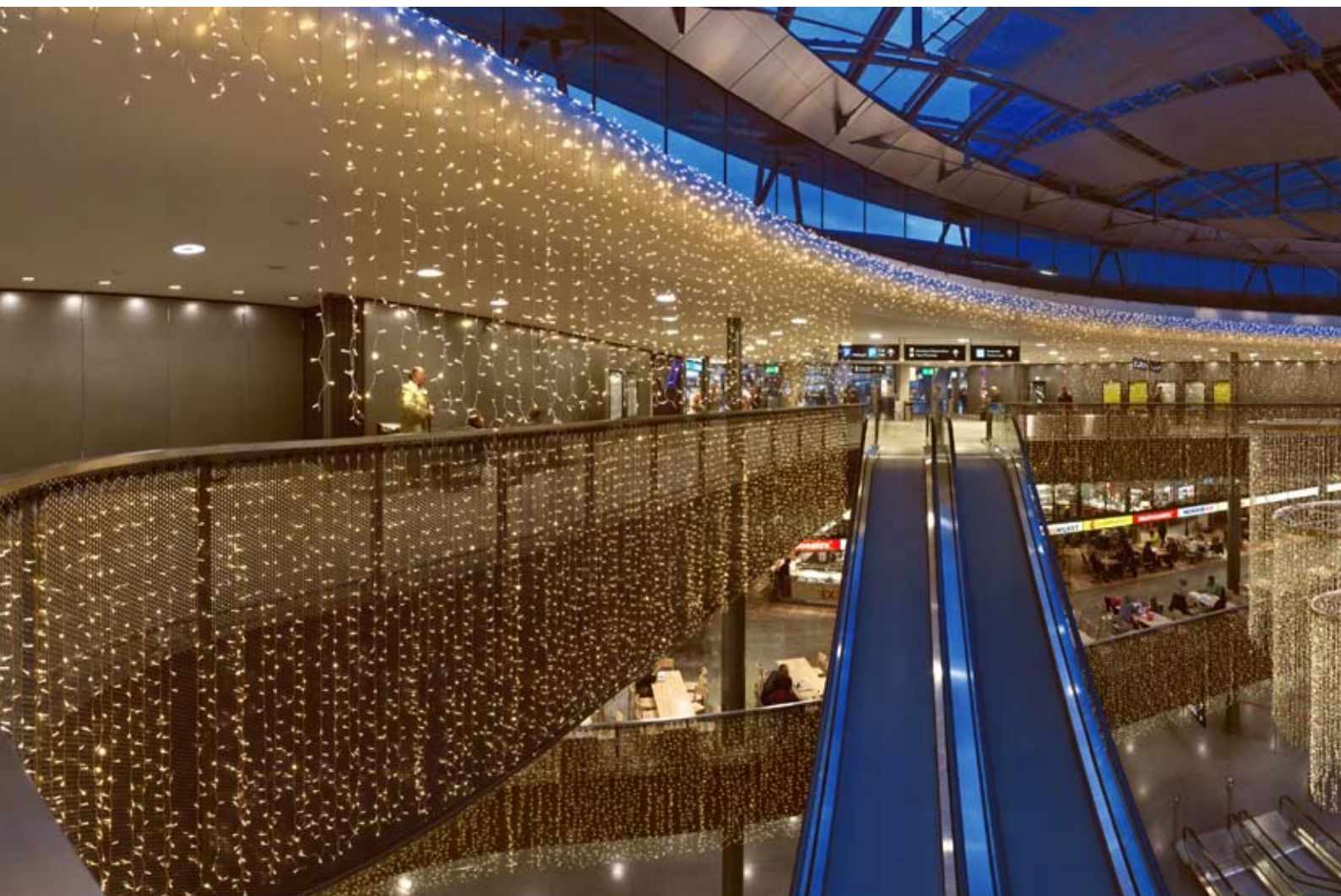

- QuickFix® Indoor kompatibel
- kein Trafo notwendig
- koppel- und erweiterbar
- Segmente austauschbar





### LED DRAPE LITE® 300

Dimension: 2m x 1.5m  
 Anzahl der Segmente: 20  
 Lampen pro Segment: 15  
 Länge pro Segment: 1.50 m  
 220-240 V, 35 W, LED: 300  
**2 Segmente = 1 Serie**  
 ohne Netzstecker

**LED** 017-046  
 LEDPL-1520-230VTR-WW  
 014-942 Ersatzstrang 1.5 m



transparentes  
Kabel

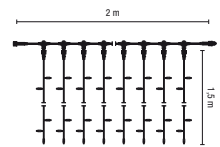

max. 10 Vorhänge koppelbar

### LED DRAPE LITE® 600

Dimension: 2m x 3m  
 Anzahl der Segmente: 20  
 Lampen pro Segment: 30  
 Länge pro Segment: 3.00 m  
 220-240 V, 35 W, LED: 600  
**2 Segmente = 1 Serie**  
 ohne Netzstecker

**LED** 017-047  
 LEDPL-3020-230VTR-WW  
 014-943 Ersatzstrang 3.0 m



transparentes  
Kabel

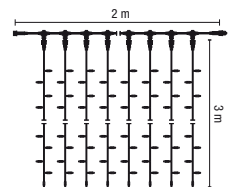

max. 7 Vorhänge koppelbar

### LED DRAPE LITE® 1200

Dimension: 2m x 6m  
 Anzahl der Segmente: 20  
 Lampen pro Segment: 60  
 Länge pro Segment: 6.00 m  
 220-240 V, 70 W, LED: 1200  
**1 Segment = 1 Serie**  
 ohne Netzstecker

**LED** 017-040  
 LEDPL-6020-230VTR-WW  
 015-063 Ersatzstrang 6.0 m



transparentes  
Kabel

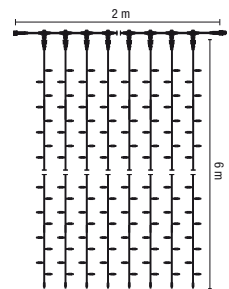

max. 3 Vorhänge koppelbar

### DRAPE LITE® Mounting Track

014-855  
 Länge: 2.08m



- ① Alu-Schiene
- ② Fixierungsstange mit Kabelbinder
- ③ Kunststoffbolzen

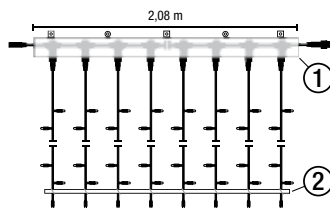

Nur für DRAPE LITE® geeignet!

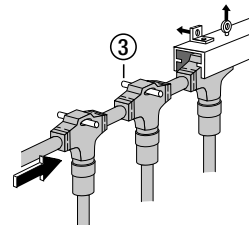

### LED QuickFix® Main Connector Indoor

220-240 V  
 max. Belastbarkeit: 480 W

	EU	UK	CH
	014-937	015-064	015-065

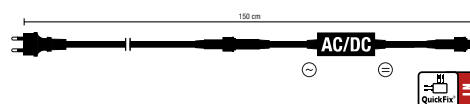

transparentes  
Kabel



# Rope Light & Accessories

## 100% LED

**Rope Light Outdoor 230 V** – aneinander gereihte, in einem biegsamen PVC-Schlauch eingegossene LED-Lichtpunkte in verschiedenen Farben. Dank des QuickFix® Systems sind alle Rope Light Outdoor 230 V untereinander koppelbar, entsprechen der Schutzart IP44 und sind schnell, leicht und sicher zu installieren. Sehr gut geeignet für Fassaden, Dächer, Konturen und indirekte Beleuchtung. Wichtig: Vergessen Sie nie die Anschlüsse und Endkappen zu verkleben!

Wählen Sie passend zu Ihrem Projekt einen Lichtschlauch aus.

Die Idee von Ihnen, der Lichtschlauch von MK mit:

- bestimmter Ausrichtung der LED
- bestimmter Anzahl der LED's/m
- bestimmten Segmentlängen

QuickFix® Outdoor kompatibel  
kein Trafo notwendig  
koppel- und erweiterbar  
Segmente austauschbar

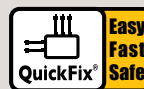

# ROPE LIGHT 36

Rubber 230 V



- QuickFix® Outdoor kompatibel
- 36 LEDs pro Meter
- Länge pro Segment: 1,5 m und 2 m
- hohe Leuchtkraft





### LED ROPE LIGHT 36 – 45m

Ø 13mm  
 max. Länge: 90m - 2 Rollen  
 Lampen pro Segment: 54  
 Länge pro Segment: 1.50 m  
 Watt/Segment: 3.5 W  
 220-240 V, 104 W, LED: 1620



**LED** 248-028  
 LED45M-H-230VWW

**LED** 248-001  
 LED45M-H-230VWH

**LED** 248-002  
 LED45M-H-230VBL

**LED** 248-004  
 LED45M-H-230VGR

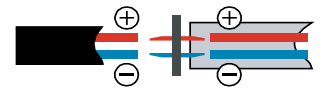

Anschluss LED Lichtslauch  
 Überprüfen Sie vor Inbetriebnahme die  
 Ausrichtung der Anschlusspins.

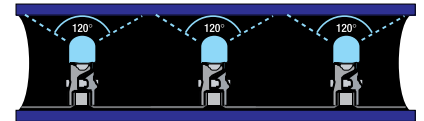

punktgenaue Lichtwirkung  
 Diodenabstand: 2,77 cm

### LED ROPE LIGHT 36 - 44m

Ø 13mm  
 max. Länge: 88m - 2 Rollen  
 Lampen pro Segment: 72  
 Länge pro Segment: 2.00 m  
 Watt/Segment: 3.5 W  
 220-240 V, 76 W, LED: 1584



**LED** 248-005  
 LED44M-H-230VRO

**LED** 248-003  
 LED44M-H-230VAM



### LED QuickFix® Main Connector

Anschluss: Zuleitung an LED QuickFix®  
 mit Gleichrichter, max. Belastbarkeit: 480 W

	EU	UK	CH
	014-418	015-070	015-071
	014-419	015-072	015-073

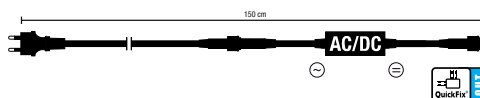

# ROPE LIGHT 30

Rubber 230 V



- QuickFix® Outdoor kompatibel
- 30 LEDs pro Meter
- Länge pro Segment: 1 m
- 360° optimale Lichtstreuung



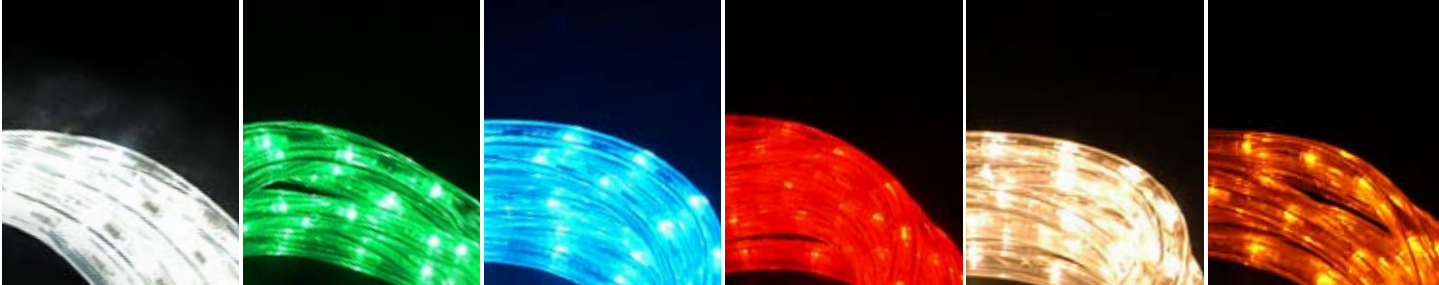

### LED ROPE LIGHT 30 – 45m

Ø 13mm  
 max. Länge: 90m - 2 Rollen  
 Lampen pro Segment: 30  
 Länge pro Segment: 1.00 m  
 Watt/Segment: 3.5 W  
 220-240 V, 157.5 W, LED: 1350



- 248-058**  
LED45M-C-230VWW
- 248-057**  
LED45M-C-230VWH
- 248-059**  
LED45M-C-230VBL
- 248-060**  
LED45M-C-230VGR
- 248-061**  
LED45M-C-230VRO
- 248-062**  
LED45M-C-230VAM

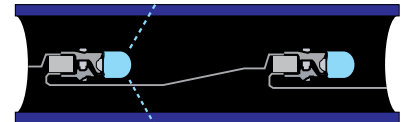

diffuse Lichtwirkung (360°)  
 Diodenabstand: 3,3 cm



### LED ROPE LIGHT 30 – 45m

Ø 13mm  
 max. Länge: 90m - 2 Rollen  
 Lampen pro Segment: 30  
 Blitz-LED pro Segment: 5  
 Länge pro Segment: 1.00 m  
 Watt/Segment: 3.5 W  
 220-240 V, 157.5 W, LED: 1350



- 248-063**  
LED45M-C-230VWH-WHFL

### LED QuickFix® Main Connector

Anschluss: Zuleitung an LED QuickFix®  
 mit Gleichrichter, max. Belastbarkeit: 480 W

	EU	UK	CH
	014-418	015-070	015-071
	014-419	015-072	015-073

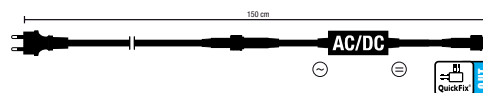

# ROPE LIGHT 24

Rubber 230 V



- QuickFix® Outdoor kompatibel
- 24 LEDs pro Meter
- Länge pro Segment: 2,5 m und 3 m
- 360° optimale Lichtstreuung



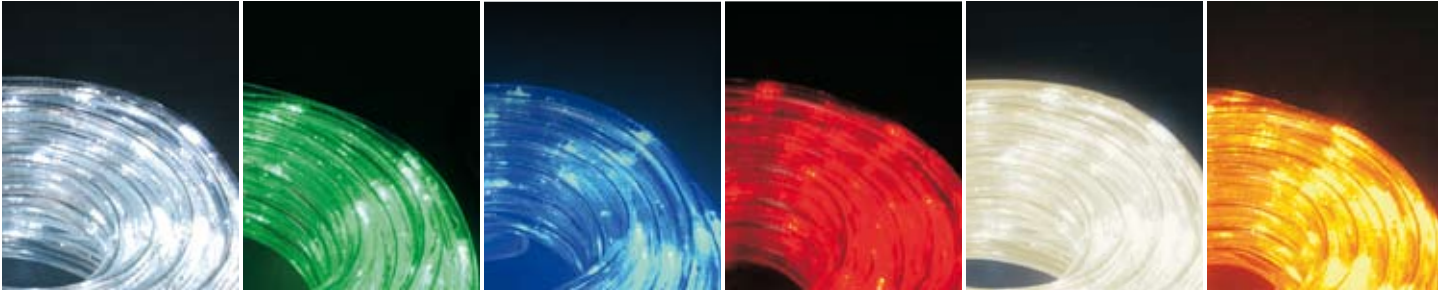

### LED ROPE LIGHT 24 – 45m

Ø 13mm  
 max. Länge: 90m - 2 Rollen  
 Lampen pro Segment: 60  
 Länge pro Segment: 2.50 m  
 Watt/Segment: 3.5 W  
 220-240 V, 62 W, LED: 1080



- LED** 248-027  
LED45M-D-230VWW
- LED** 248-006  
LED45M-D-230VWH
- LED** 248-007  
LED45M-D-230VBL
- LED** 248-009  
LED45M-D-230VGR

**LED**  
 warmweiß  
 milchig

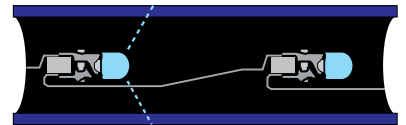

diffuse Lichtwirkung (360°)  
 Diodenabstand: 4,16 cm

### LED ROPE LIGHT 24 – 45m

Ø 13mm  
 max. Länge: 90m - 2 Rollen  
 Lampen pro Segment: 72  
 Länge pro Segment: 3.00 m  
 Watt/Segment: 3.5 W  
 220-240 V, 52 W, LED: 1080



- LED** 248-010  
LED45M-D-230VRO
- LED** 248-008  
LED45M-D-230VAM



### LED QuickFix® Main Connector

Anschluss: Zuleitung an LED QuickFix®  
 mit Gleichrichter, max. Belastbarkeit: 480 W

	EU	UK	CH
	014-418	015-070	015-071
	014-419	015-072	015-073

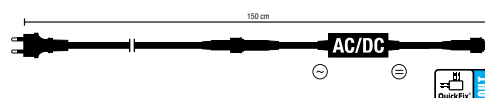

# ACCESSORIES

## LICHTSCHLAUCH

### ROPE LIGHT TRACK PET

244-009  
Befestigungsschiene aus PET  
Länge: 2m

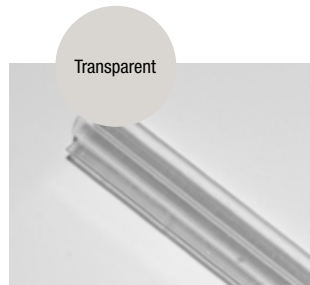

### ROPE LIGHT TRACK ALU

244-010  
Befestigungsschiene aus ALU  
Länge: 2m

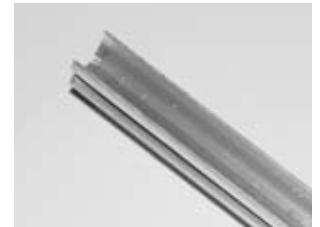

## LED MAIN CONNECTION SET



**Anschluss-Set für LED Lichtschlauch**  
inkl. AC/DC-Wandler, mit Endkappe, Lösungsmittelkleber,  
Einspeisepin und 2 Schrumpfschläuchen

- EU** 444-001
- UK** 444-002
- CH** 444-003

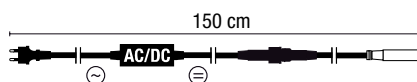

### QuickFix® RopeLight Adapter

**Adapter: ROPE LIGHT an QuickFix®**  
mit Endkappe, Lösungsmittelkleber, Einspeisepin und 2 Schrumpfschläuchen  
max. Belastbarkeit: 740 W

- 244-033
- 244-034
- 244-244



### QuickFix® RopeLight Extension to RopeLight

**Adapter: ROPE LIGHT an QuickFix®**  
mit Endkappe, Lösungsmittelkleber, Einspeisepin und 2 Schrumpfschläuchen  
max. Belastbarkeit: 740 W

- 244-230
- 244-231
- 244-245

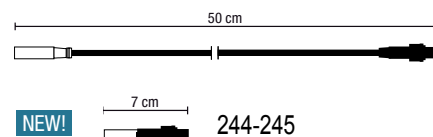

## ENDCAPS

244-218  
10 Endkappen, 10 Schrumpfschläuche

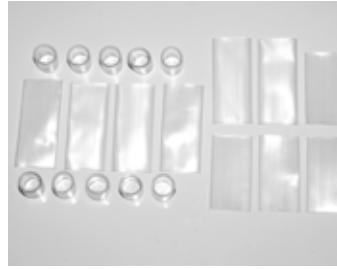

## FEEDING ELEMENTS

244-219  
verbindet Anschlusskabel mit Ropelight  
Verpackungsinhalt: 10



## ENDCAP SET

244-023  
1 Kunststoffkleber, 3 Schrumpfschläuche,  
3 Endkappen



## SPLICE CONNECT

244-217  
verbindet Ropelight mit Ropelight  
Verpackungsinhalt: 10



## CONNECTOR SET

244-002  
2 Verbindungskupplungen,  
2 Verbindungspins,  
1 Kunststoffkleber,  
4 Schrumpfschläuche



## CROCODILE CLIP

244-005  
Verpackungsinhalt: 25



## T-CONNECTOR SET

244-003  
1 T-Verbinder, 3 Einspeisepins, 2 Endkappen,  
1 Kunststoffkleber, 5 Schrumpfschläuche



244-015  
Verpackungsinhalt: 100



## GLUE

244-006  
1 Kunststoffkleber



## MOUNTING CLIP

244-014  
Verpackungsinhalt: 100





*glittering  
brilliant  
luminous  
festive*

# Deco & Green

by MK Illumination

**Deco & Green** – traditionelle, handgefertigte Dekorationen, Kunstbäume und Grüngirlanden. Komplett mit warmweißen LED Lichtpunkten bestückt und in Top B1 geprüfter Qualität. Die natürliche Farbe des dichten Buschwerks aus Tinsel-Tipps und Spritzguss-Tipps sowie die hohe Dichte an verarbeiteten Tipps geben der Grünware einerseits ein echtes Aussehen und andererseits ein bildschönes, festliches Lichtbild. Und das besondere und einzigartige an MK Girlanden: Jede einzelne Lampe ist jeweils an einem Tipp befestigt und die Kabel wurden ins Innere des Produkts gelegt.

ideal für kreative Ideen  
einfache Handhabung  
Tagwirkung

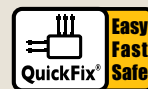

# QuickFix® TREES & GARLANDS

230 V – OUTDOOR



- B1 geprüfte Qualität
- hohe Anzahl an Tipps – sehr dichte Verarbeitung
- jede einzelne Lampe ist immer an einem Tipp befestigt
- Kabel im Inneren des Produktes verarbeitet
- natürliche Farbe der Tipps, daher ein sehr natürliches Aussehen
- variable Lichtbestückung
- Kartongröße dem Produkt angepasst
- direkt aus dem Karton aufstellen – ohne großen Aufwand
- optimale Transportverpackung
- kostengünstige Lagerung

#### QuickFix® Tree

- Tinsel Tipps und Spritzguss Tipps +
- inkl. stabilen Standbein
- sehr geringe bis keine Bodenfreiheit
- Äste mit der „hinged on“ Technik befestigt
- koppelbar

#### QuickFix® Simple Garland / Swag Garland

- variabel mit Stahlseil oder pulverbeschichtetem Stahlrohr lieferbar
- direkt aus dem Karton aufhängen – ohne großen Aufwand
- Verpackung: Kartons haben Palettenmaße. 4-5 Kartons stapelbar / Palette
- koppel- und erweiterbar



## QuickFix® TREE

Dimension: Ø 1.2m x 2.1m  
LED: 720  
220-240 V, 52.8 W

**LED** 014-524



ohne  
Netzstecker



Ohne Dekoration

## **LED** QuickFix® Main Connector

**Anschluss: Zuleitung an LED QuickFix®**  
mit Gleichrichter, max. Belastbarkeit: 480 W

	EU	UK	CH
	014-418	015-070	015-071

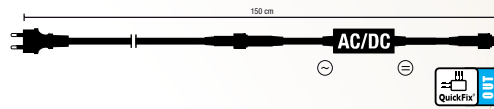

## QuickFix® SIMPLE GARLAND

Dimension: Ø 0.3m x 2m  
LED: 240  
220-240 V, 17.6 W  
max. 5 Girlanden koppelbar  
2 Sk. / Packung

**LED** 014-485



Dimension: Ø 0.4m x 2m  
LED: 360  
220-240 V, 26.4 W  
max. 4 Girlanden koppelbar  
2 Sk. / Packung

**LED** 014-486

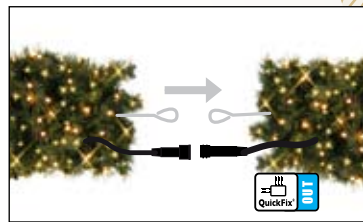

integrierte Metallstange + QuickFix® Anschluss



integriertes Stahlseil mit Seilkautschke

- koppel- und erweiterbar
- optimale Transportverpackung

ohne  
Netzstecker



## QuickFix® SWAG GARLAND

Dimension: Ø 0.14m x 2.7m  
LED: 360  
220-240 V, 26.4 W  
max. 4 Girlanden koppelbar

**LED** 014-490



Dimension: Ø 0.14m x 5m  
LED: 540  
220-240 V, 39.6 W  
max. 2 Girlanden koppelbar

**LED** 014-491

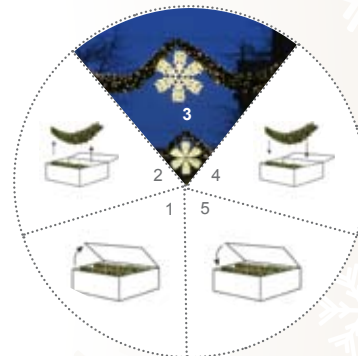

ohne  
Netzstecker

- koppel- und erweiterbar
- optimale Transportverpackung



# QuickFix® TREES & GARLANDS

230 V – INDOOR



- B1 geprüfte Qualität
- hohe Anzahl an Tipps – sehr dichte Verarbeitung
- jede einzelne Lampe ist immer an einem Tipp befestigt
- Kabel im Inneren des Produktes verarbeitet
- natürliche Farbe der Tipps, daher ein sehr natürliches Aussehen
- variable Lichtbestückung
- Kartongröße dem Produkt angepasst
- direkt aus dem Karton aufstellen – ohne großen Aufwand
- optimale Transportverpackung
- kostengünstige Lagerung

## QuickFix® Tree

- Tinsel Tipps und Spritzguss Tipps +
- inkl. stabilen Standbein
- sehr geringe bis keine Bodenfreiheit
- Äste mit der „hinged on“ Technik befestigt
- koppelbar

## QuickFix® Simple Garland / Swag Garland

- variabel mit Stahlseil oder pulverbeschichtetem Stahlrohr lieferbar
- direkt aus dem Karton aufhängen – ohne großen Aufwand
- Verpackung: Kartons haben Palettenmaße. 4-5 Kartons stapelbar / Palette
- koppel- und erweiterbar

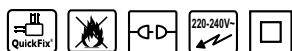

## QuickFix® TREE

ohne  
Netzstecker

Dimension: Ø 1.2m x 1.8m  
LED: 570  
220-240 V, 39.6 W

**LED** 015-625



Dimension: Ø 1.4m x 2.1m  
LED: 760  
220-240 V, 52.8 W

**LED** 015-626



Dimension: Ø 1.5m x 2.3m  
LED: 1140  
220-240 V, 79.2 W

**LED** 015-627



Ohne Dekoration

## QuickFix® SIMPLE GARLAND

Dimension: Ø 0.3m x 2m  
LED: 300  
220-240 V, 22 W  
max. 4 Girlanden koppelbar  
2 Sk. / Packung

**LED** 014-487



Dimension: Ø 0.4m x 2m  
LED: 360  
220-240 V, 26.4 W  
max. 4 Girlanden koppelbar  
2 Sk. / Packung

**LED** 014-488

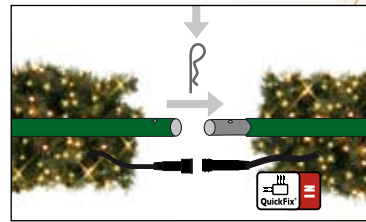

integrierte Metallstange + QuickFix® Anschluss



gesicherte Steckverbindung

- koppel- und erweiterbar
- optimale Transportverpackung

ohne  
Netzstecker



## QuickFix® SWAG GARLAND

Dimension: Ø 0.14m x 2.7m  
LED: 360  
220-240 V, 26.4 W  
max. 4 Girlanden koppelbar

**LED** 014-489



- koppel- und erweiterbar
- optimale Transportverpackung

ohne  
Netzstecker



## **LED** QuickFix® MAIN CONNECTOR INDOOR

220-240 V  
max. Belastbarkeit: 480 W

	EU	UK	CH	
	014-937	015-064	015-065	
	015-618			

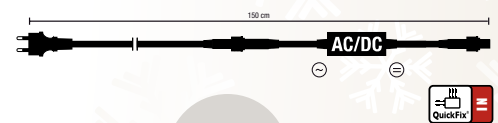

transparentes  
Kabel

# GIANT CHRISTMAS TREE

INDOOR / OUTDOOR



- variable Bestückung (Farben / Indoor / Outdoor)
- höhenverstellbar bzw. erweiterbar
- sehr dichte Machart
- professionelle Lichteinbarung
- schneller, einfacher Auf- und Abbau

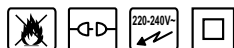

## GIANT INDOOR CHRISTMAS TREE

mit Lichterkette für den Innenbereich, ohne Kugeln

Dimension: Ø 1.6m x 3.7m  
220-240 V, 176 W

**LED** 014-376  1

Dimension: Ø 3.55m x 8.6m  
220-240 V, 836 W

**LED** 014-378  1

Dimension: Ø 5.16m x 12.8m  
220-240 V, 1188 W

**LED** 014-380  1

Dimension: Ø 2.45m x 5.8m  
220-240 V, 422 W

**LED** 014-377  1

Dimension: Ø 4.35m x 10.7m  
220-240 V, 1012 W

**LED** 014-379  1

## GIANT INDOOR/OUTDOOR CHRISTMAS TREE

ohne Lichterketten, ohne Kugeln

Dimension: Ø 1.6m x 3.7m  
014-370

 1

Dimension: Ø 3.55m x 8.6m  
014-372

 1

Dimension: Ø 5.16m x 12.8m  
014-375

 1

Dimension: Ø 2.45m x 5.8m  
014-371

 1

Dimension: Ø 4.35m x 10.7m  
014-373

 1



# DECO AIR BALLS



931-478	Stella		150 x 170 x 150 cm	~3 kg
931-479	Stella		150 x 170 x 150 cm	~3 kg
931-480	Modern		150 x 170 x 150 cm	~3 kg
931-481	Ice		200 x 220 x 200 cm	~4 kg
931-482	Ice		150 x 170 x 150 cm	~3 kg
931-483	Floris		150 x 170 x 150 cm	~3 kg
931-486	Floris		150 x 170 x 150 cm	~3 kg

= gold glossy  
 = silver glossy  
 = hellbraun



Modern



Ice



Ice



Floris



Floris



Stella



Stella

# DECO CHRISTMASBALLS



• schwer entflammbar

*matt  
bordeaux gold  
champagne*

CHRISTMASBALL Ø 7 cm

014-713	Gold glänzend
014-714	Gold matt
014-715	Rot glänzend
014-716	Rot matt
014-717	Champagner glänzend
014-718	Champagner matt
014-721	Kupfer glänzend
014-722	Kupfer matt

10

CHRISTMASBALL Ø 10 cm

014-725	Gold glänzend
014-726	Gold matt
014-727	Rot glänzend
014-728	Rot matt
014-729	Champagner glänzend
014-730	Champagner matt
014-733	Kupfer glänzend
014-734	Kupfer matt

4

CHRISTMASBALL Ø 14 cm

014-749	Gold glänzend
014-750	Gold matt
014-751	Rot glänzend
014-752	Rot matt
014-753	Champagner glänzend
014-754	Champagner matt
014-757	Kupfer glänzend
014-758	Kupfer matt

1

CHRISTMASBALL Ø 20 cm

014-761	Gold glänzend
014-762	Gold matt
014-763	Rot glänzend
014-764	Rot matt
014-765	Champagner glänzend
014-766	Champagner matt
014-769	Kupfer glänzend
014-770	Kupfer matt

1

# CRYSTAL CHAINS

LOW VOLTAGE





- QuickFix® Low Voltage kompatibel
- hohe Leuchtkraft – brilliant auf 360°
- koppel- und erweiterbar
- transparentes Kabel
- Glaskristalle
- ohne Trafo
- koppelbar im System 80



**36V LED CRYSTAL LITE® 40**

Länge: 4m  
Anzahl der Segmente: 1  
Lampen pro Segment: 40  
Länge pro Segment: 4.00 m  
36 V, 1.5 W, LED: 40









-   **LED** **028-021**  
LEDPL-40-36VTR-WW
-   **LED** **028-022**  
LEDPL-40-36VTR-WH



**36V LED CRYSTAL LITE® 40**

Länge: 4m  
Anzahl der Segmente: 1  
Lampen pro Segment: 40  
Blitz-LED pro Segment: 5  
Länge pro Segment: 4.00 m  
36 V, 1.5 W, LED: 40



-    **LED** **028-039**  
LEDPL-40-36VTR-WW-WHFL
-    **LED** **028-040**  
LEDPL-40-36VTR-WH-WHFL

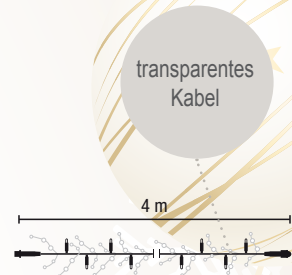

koppel- und erweiterbar – siehe Seite 77



**CRYSTAL CHAIN**

**015-017**  
Länge: 4m



**015-018**  
Länge: 4m

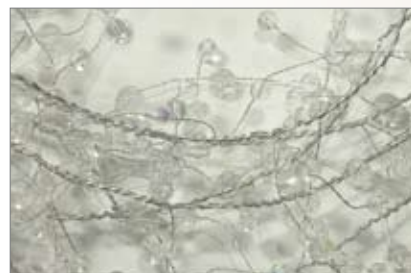

*crystal  
luminous gold  
silver*

# TWIG LIGHT

LOW VOLTAGE



## LED TWIG LITE®

Höhe: 1m  
 Anzahl der Segmente: 1  
 Lampen pro Segment: 120  
 36 V, 4.3 W, LED: 120

 **LED** 028-062

 **LED** 028-063

 **LED** 028-045



## STICK

Höhe: 1m

 015-594

 015-595

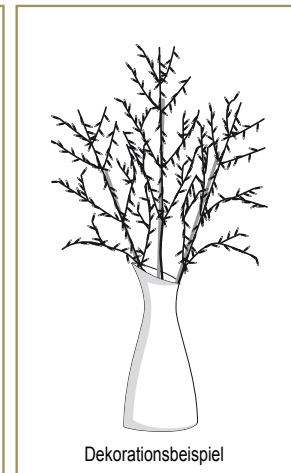
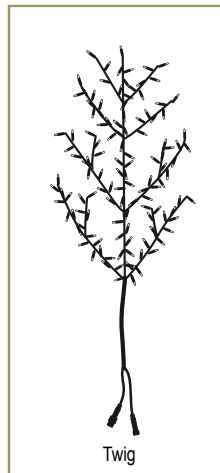

- biegsame Äste
- ohne Trafo
- koppelbar im System 80



# DECO STARS

014-872



014-873



DECO STAR Ø 55cm

 014-872



DECO STAR Ø 75cm

 014-873



- schwer entflammbar
- zwei Befestigungsösen





# ORGANIC BALLS

Organic Balls Ø 10 cm



 931-643

 938-036

 931-863

 931-881

 938-024

Organic Balls Ø 12 cm



 931-644

 938-037

 931-864

 931-866

 938-025



# LED WALLWASHER

PROJEKTBEZOGEN – AUF ANFRAGE



- variable Optik
- hohe Leuchtkraft
- High Power LED



*light* *glittering*  
*luminous* *colour*  
*sparkling*

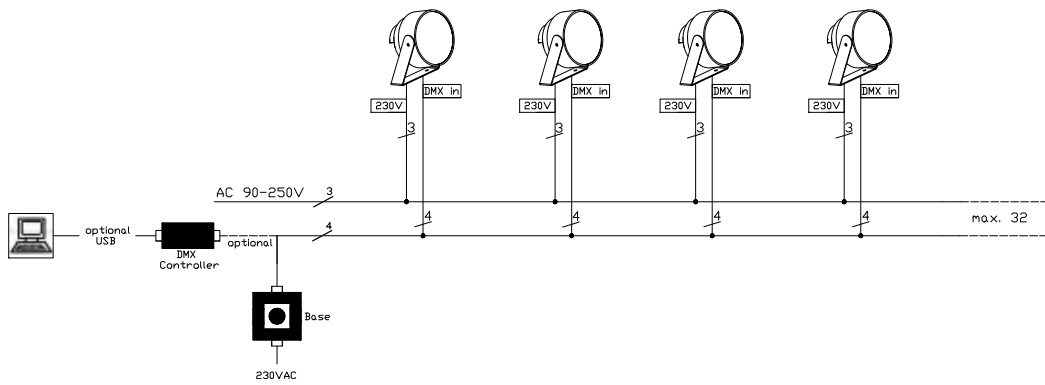

## Wallwasher SPOT



230V

Farbe	ø mm	LEDs	W	kg
	123	12	17	2 kg
	123	12	17	2 kg
	123	12	17	2 kg
	123	12	17	2 kg
	123	12	17	2 kg



230V / DMX

Farbe	ø mm	LEDs	W	kg
	123	12	17	2 kg



230V / RGB DMX

Farbe	ø mm	LEDs	W	kg
	123	12	17	2 kg

### Angle °

- 10° spot
- 30° medium
- 50° flood

## Accessories



BASE DMX controller, 4W, 230V



Stecker & Verbindungen

# LED WALLWASHER

PROJEKTBEZOGEN – AUF ANFRAGE

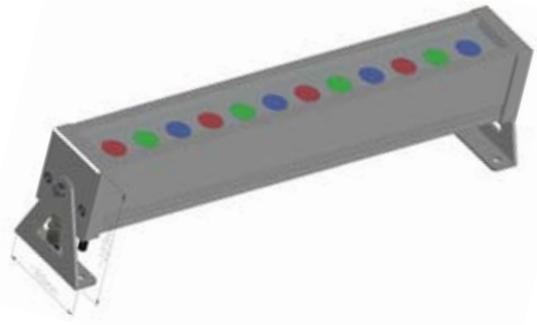

- variable Optik
- hohe Leuchtkraft
- High Power LED



*light* *glittering*  
*luminous* *colour*  
*sparkling*

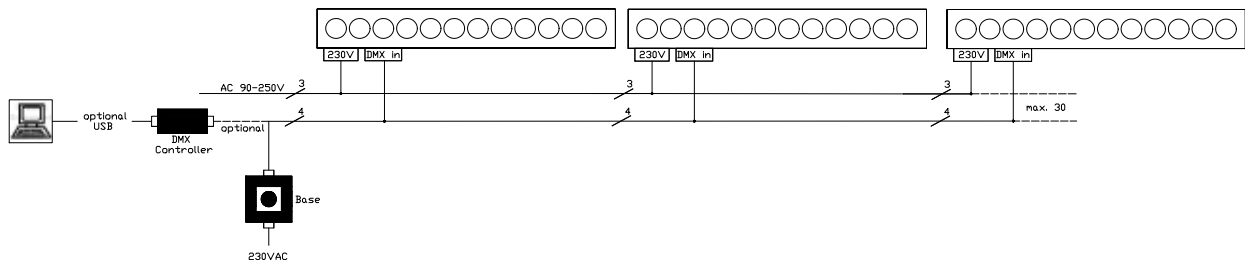

## Wallwasher BAR



### 230V

Farbe	mm	LEDs	W	kg
	400	12	16	2,7 kg
	800	24	32	5,1 kg
	1.200	36	47	8,1 kg
	400	12	16	2,7 kg
	800	24	32	5,1 kg
	1.200	36	47	8,1 kg
	400	12	16	2,7 kg
	800	24	32	5,1 kg
	1.200	36	47	8,1 kg
	400	12	16	2,7 kg
	800	24	32	5,1 kg
	1.200	36	47	8,1 kg
	400	12	16	2,7 kg
	800	24	32	5,1 kg
	1.200	36	47	8,1 kg

### 230V / DMX

Farbe	mm	LEDs	W	kg
	400	12	16	2,7 kg
	800	24	32	5,1 kg
	1.200	36	47	8,1 kg

### 230V / RGB DMX

Farbe	mm	LEDs	W	kg
	400	12	16	2,7 kg
	800	24	32	5,1 kg
	1.200	36	47	8,1 kg

### Angle °

30°	medium
50°	flood
10° x 40°	special

### Accessories



BASE DMX controller, 4W, 230V



Stecker & Verbindungen



# QuickFix® Collections

**QuickFix® Collection 230 V** – uneingeschränkt und individuell konzipierbare Kleinmotivgruppe. Flexibel einsetzbar weil sie direkt mit der QuickFix® Outdoor Produktreihe verbunden werden können. Bei der Verwendung mit der QuickFix® Indoor Produktreihe ist ein spezieller T-Verbinder notwendig. In dieser Collection werden teilweise „organics materials“ verarbeitet, die zu 100 Prozent recyclebar, wasser- sowie wetterfest und UV-Licht beständig sind.



QuickFix® kompatibel  
einfache Planung – schnelle Umsetzung  
Schutzart IP44  
SCHUTZKLASSE 2

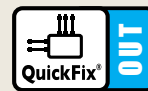

# COLLECTION ORGANIC



1 part



## ORGANIC BALL 17

	938-006	938-007	938-008	938-009	938-010
	Ø ~17cm	Ø ~17cm	Ø ~17cm	Ø ~17cm	Ø ~17cm
	~0.75 kg	~0.75 kg	~0.75 kg	~0.75 kg	~0.75 kg
	~5 W	~5 W	~5 W	~5 W	~5 W
	LED	LED	LED	LED	LED
	T-1	T-1	T-1	T-1	T-1

☆ 3D / 1 part 6

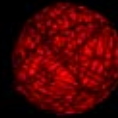

## ORGANIC BALL 22

	938-001	938-002	938-003	938-004	938-005
	Ø ~22cm	Ø ~22cm	Ø ~22cm	Ø ~22cm	Ø ~22cm
	~0.85 kg	~0.85 kg	~0.85 kg	~0.85 kg	~0.85 kg
	~5 W	~5 W	~5 W	~5 W	~5 W
	LED	LED	LED	LED	LED
	T-1	T-1	T-1	T-1	T-1

☆ 3D / 1 part 6



motif details  
[www.mk-illumination.com/collections](http://www.mk-illumination.com/collections)

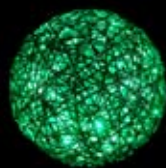
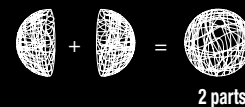

ORGANIC BALL 40

	931-894	931-895	931-896	931-897	931-898
∠	Ø ~40cm	Ø ~40cm	Ø ~40cm	Ø ~40cm	Ø ~40cm
◇	~1.8 kg	~1.8 kg	~1.8 kg	~1.8 kg	~1.8 kg
⚡	~3 W	~3 W	~3 W	~3 W	~3 W
✂	LED	LED	LED	LED	LED
✂	T-1	T-1	T-1	T-1	T-1

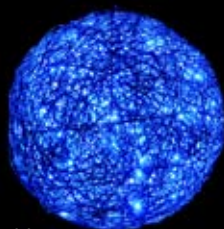
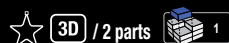

ORGANIC BALL 60

	931-376	931-378	931-380	931-382	931-384
∠	Ø ~60cm	Ø ~60cm	Ø ~60cm	Ø ~60cm	Ø ~60cm
◇	~4.3 kg	~4.3 kg	~4.3 kg	~4.3 kg	~4.3 kg
⚡	~6 W	~6 W	~6 W	~6 W	~6 W
✂	LED	LED	LED	LED	LED
✂	T-1	T-1	T-1	T-1	T-1

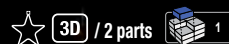

ORGANIC BALL 80

	931-386	931-388	931-390	931-392	931-394
∠	Ø ~80cm	Ø ~80cm	Ø ~80cm	Ø ~80cm	Ø ~80cm
◇	~6.8 kg	~6.8 kg	~6.8 kg	~6.8 kg	~6.8 kg
⚡	~6 W	~6 W	~6 W	~6 W	~6 W
✂	LED	LED	LED	LED	LED
✂	T-1	T-1	T-1	T-1	T-1

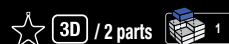

# COLLECTION ORGANIC



## ORGANIC TREE

	931-423	931-425
	~64 x 78 x 36cm	~78 x 102 x 38cm
	~3.7 kg	~5.6 kg
	~6 W	~12 W
	LED	LED
	T-1	T-1



## ORGANIC PINE

	931-431	931-433
	~44 x 76 x 44cm	~55 x 96 x 55cm
	~3 kg	~5.5 kg
	~6 W	~12 W
	LED	LED
	T-1	T-1



## ORGANIC STAR

	931-439	931-420
	~60 x 60 x 20cm	~102 x 102 x 36cm
	~2.6 kg	~4.1 kg
	~6 W	~12 W
	LED	LED
	T-1	T-1



## ORGANIC HEART

	931-427	931-429
	~62 x 60 x 33cm	~82 x 78 x 33cm
	~2.9 kg	~4.3 kg
	~6 W	~12 W
	LED	LED
	T-1	T-1



## ORGANIC BELL

	931-435	931-437
	~66 x 88 x 26cm	~90 x 115 x 28cm
	~3.3 kg	~5.4 kg
	~6 W	~12 W
	LED	LED
	T-1	T-1







CRYSTAL CHANDELIER PARIS

938-073

~ Ø145 x 80cm

~13 kg

~15 W



T-1



36V, incl. Transformer

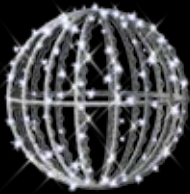

MERIDIAN

032-218

Ø ~40cm



LED

T-1



☆+⌚ 941-061

032-217

Ø ~40cm

~3 kg

~15 W

LED

T-1



SNOWBALL

923-314

Ø ~40cm



LED

T-1



☆+⌚ 941-061

923-659

Ø ~40cm

~2 kg

~20 W

LED

T-1

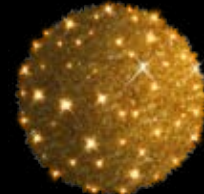

SKYBALL 3D

933-668

Ø ~40cm



LED

T-1



☆+⌚ 941-061

933-662

Ø ~40cm

~3.5 kg

~9 W

LED

T-1

933-665

Ø ~40cm

~3.5 kg

~9 W

LED

T-1





TRADITIONAL PENTOR

**933-698**

~120 x 115cm

~7 kg

~30 W

LED

T-2



TRADITIONAL WEGA

**933-804**

~125 x 125cm

~8 kg

~35 W

LED

T-2



TRADITIONAL STAR

**933-699**

Ø ~120cm

~7kg

~30 W

LED

T-2



TRADITIONAL BELL

**933-781**

~95 x 120cm

~8 kg

~30 W

LED

T-2



# COLLECTION STARS



## HECTA

	933-806	933-497	933-807
↙	~75 x 65cm	~75 x 65cm	~125 x 110cm
◇	~1.5 kg	~1.5 kg	~3 kg
⚡	~18 W	~18 W	~35 W
✂	LED	LED	LED
🔪	T-2	T-2	T-2
☆+⌚	941-017	941-033	941-033



## PENTOR

	933-683	933-684	032-015	032-025
↙	Ø ~70 cm	Ø ~95cm	Ø ~45cm	Ø ~45cm
◇	~1.5 kg	~2 kg	~1 kg	~1 kg
⚡	~18 W	~25 W	~4 W	~4 W
✂	LED	LED	LED	LED
🔪	T-2	T-2	T-1	T-1
☆+⌚	941-017	941-033	941-061	941-061



## COMET

	933-826
↙	~135 x 70cm
◇	~3 kg
⚡	~35 W
✂	LED
🔪	T-2
☆+⌚	941-033



## WEGA

	933-685	933-827
↙	Ø ~85cm	Ø ~120cm
◇	~2 kg	~3 kg
⚡	~25 W	~38 W
✂	LED	LED
🔪	T-2	T-2
☆+⌚	941-033	941-033





WEGA OVAL

933-808

- ↙ ~65 x 85cm
- ◇ ~2 kg
- ⚡ ~21 W
- ✂ LED
- ✂ T-2



ARIES

933-680

933-681

- |   |         |          |
|---|---------|----------|
| ↙ | Ø ~95cm | Ø ~110cm |
| ◇ | ~2.5 kg | ~3 kg    |
| ⚡ | ~28 W   | ~31 W    |
| ✂ | LED     | LED      |
| ✂ | T-2     | T-2      |



ORION

933-828

933-829

- |   |         |          |
|---|---------|----------|
| ↙ | Ø ~95cm | Ø ~125cm |
| ◇ | ~2.5 kg | ~3 kg    |
| ⚡ | ~28 W   | ~38 W    |
| ✂ | LED     | LED      |
| ✂ | T-2     | T-2      |



COLLECTION  
FLAKES



SNOW CRYSTAL

933-815

∅ ~135cm

~5.5 kg

~69 W

LED

T-2



941-033



CRYSTAL FLOWER

933-816

∅ ~85cm

~3 kg

~28 W

LED

T-2



941-017



NORTHERN CROSS

933-812

∅ ~100cm

~2.5 kg

~25 W

LED

T-2



941-033



NORWAY FLAKE

933-813

∅ ~85cm

~2.5 kg

~28 W

LED

T-2



941-017



BALTIC CRYSTAL

933-810

933-811

∅ ~100cm

∅ ~135cm

~4 kg

~5.5 kg

~42 W

~59 W

LED

LED

T-2

T-2



941-033

941-033



CLASSIC FLAKE

	933-689	933-830	032-207	032-208
∠	Ø ~85cm	Ø ~105cm	Ø ~55cm	Ø ~55cm
◇	~2.5 kg	~3 kg	~1.5 kg	~1.5 kg
⚡	~28 W	~35 W	~7 W	~7 W
✂	LED	LED	LED	LED
✂	T-2	T-2	T-1	T-1
☆	☆	☆	☆	☆
☆+⌈	941-017	941-033	941-061	941-061



FLAKE OLIVIA

	933-809
∠	Ø ~65cm
◇	~2 kg
⚡	~21 W
✂	LED
✂	T-2
☆	☆
☆+⌈	941-017



ICE

	032-011	032-209
∠	Ø ~40cm	Ø ~40cm
◇	~2 kg	~2 kg
⚡	~7 W	~7 W
✂	LED	LED
✂	T-1	T-1
☆	☆	☆
☆+⌈	941-061	941-061



SNOW FLAKE

	933-704	933-705	032-012	032-026	032-024
∠	Ø ~85cm	Ø ~105cm	Ø ~55cm	Ø ~55cm	Ø ~55cm
◇	~2.5 kg	~3kg	~1.5 kg	~1.5 kg	~1.5 kg
⚡	~25 W	~35 W	~7 W	~7 W	~7 W
✂	LED	LED	LED	LED	LED
✂	T-2	T-2	T-1	T-1	T-1
☆	☆	☆	☆	☆	☆
☆+⌈	941-017	941-033	941-061	941-061	941-061



POLARIS

	933-724	933-264	032-018	032-016	032-017
∠	~70 x 95cm	~70 x 95cm	~40 x 50cm	~40 x 50cm	~40 x 50cm
◇	~1.5 kg	~1.5 kg	~1 kg	~1 kg	~1 kg
⚡	~18 W	~18 W	~4 W	~4 W	~4 W
✂	LED	LED	LED	LED	LED
✂	T-2	T-2	T-1	T-1	T-1
☆	☆	☆	☆	☆	☆
☆+⌈	941-017	941-017	941-061	941-061	941-061



# COLLECTION ASTERO



ASTERO 1

	933-761	933-500
	Ø ~65cm	Ø ~65cm
	~1 kg	~1 kg
	~11 W	~11 W
	x1	
	941-017	941-017



ASTERO 1

	032-210	032-215
	Ø ~65cm	Ø ~65cm
	~1 kg	~1 kg
	~7 W	~7 W
	x1	
	941-061	941-061

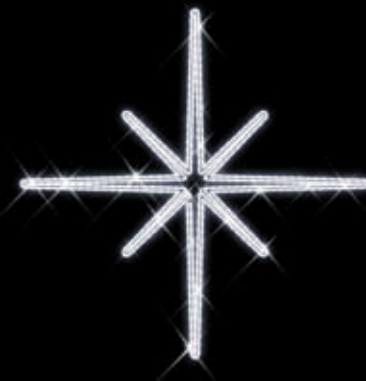

ASTERO STAR

	933-499	933-415
	Ø ~105cm	Ø ~145cm
	~2.5 kg	~4 kg
	~35 W	~52 W
	x1	
	941-033	941-033



ASTERO 2

	933-833	933-834
	~70 x 75cm	~70 x 75cm
	~1 kg	~1 kg
	~11 W	~11 W
	x1	
	941-017	941-017



ASTERO 3

	933-831	933-832
	~130 x 130cm	~130 x 130cm
	~3 kg	~3 kg
	~35 W	~35 W
	x1	
	941-033	941-033





# COLLECTION GLITTER BALLS

motif details  
[www.mk-illumination.com/collections](http://www.mk-illumination.com/collections)



**BALL ASTERO**

	933-819	933-820
∠	Ø ~95cm	Ø ~95cm
◇	~3.5 kg	~3.5 kg
⚡	~45 W	~45 W
✂	LED	LED
✂	T-2	T-2
☆	☆	☆
☆+⌚	941-033	941-033



**BALL GRID**

	933-818	933-512
∠	Ø ~95cm	Ø ~95cm
◇	~3.5 kg	~3.5 kg
⚡	~45 W	~45 W
✂	LED	LED
✂	T-2	T-2
☆	☆	☆
☆+⌚	941-033	941-033



**2D MERIDIAN**

	032-221	032-222	933-957	933-958
∠	Ø ~50cm	Ø ~50cm	Ø ~75cm	Ø ~75cm
◇	~1.5 kg	~1.5 kg	~2.5 kg	~2.5 kg
⚡	~12 W	~12 W	~17 W	~17 W
✂	LED	LED	LED	LED
✂	T-1	T-1	T-1	T-1
☆	☆	☆	☆	☆
☆+⌚	941-061	941-061	941-061	941-061



**BALL POLAR**

	933-821	933-822
∠	Ø ~95cm	Ø ~95cm
◇	~3 kg	~3 kg
⚡	~42 W	~42 W
✂	LED	LED
✂	T-2	T-2
☆	☆	☆
☆+⌚	941-033	941-033



**BALL PENTOR**

	933-823	933-824
∠	Ø ~95cm	Ø ~95cm
◇	~2.5 kg	~2.5 kg
⚡	~35 W	~35 W
✂	LED	LED
✂	T-2	T-2
☆	☆	☆
☆+⌚	941-033	941-033



**TWIG**

	933-517
∠	~120 x 55cm
◇	~3.5 kg
⚡	~45 W
✂	LED
✂	T-2
☆	☆
☆+⌚	941-033

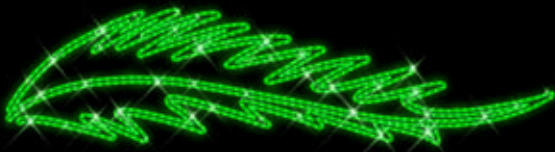

**TWIG**

	933-518
∠	~220 x 55cm
◇	~5.5 kg
⚡	~69 W
✂	LED
✂	T-3
☆	☆
☆+⌚	941-033



**TIE**

	933-519
∠	~175 x 40cm
◇	~2 kg
⚡	~21 W
✂	LED
✂	T-2
☆	☆
☆+⌚	941-033

# QuickFix® COLLECTIONS ANWENDUNGEN

- 1 direkt mit einem QuickFix®-Outdoor Verbinder ausgestattet
- 2 koppelbar mit den QuickFix® Outdoor Produkten
- 3 koppelbar mit QuickFix®-Indoor Produkten (mit Adapter 015-076)
- 4 perfekt abgestimmt auf die Collections Designs und Gruppen
- 5 sowohl für Hängemontage als auch für Mastmontage geeignet
- 6 beschichtete Konstruktion
- 7 optionales Zubehör für die Mastmontage
- 8 optionales Anschlusskabel mit Netzstecker erhältlich

QuickFix® Collection Motif  
Auslieferungsstandard

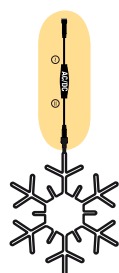
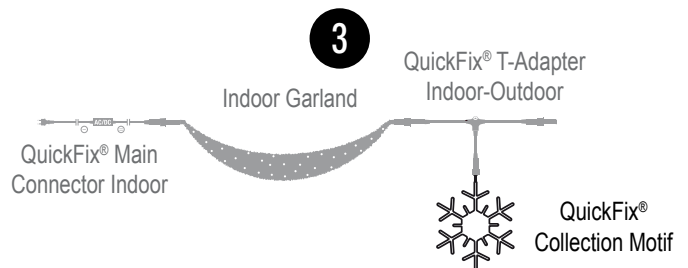
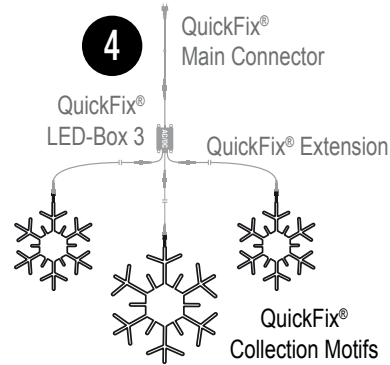
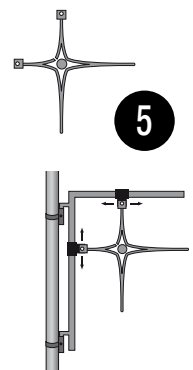
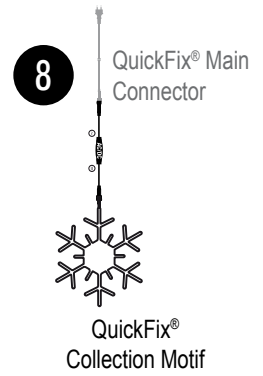
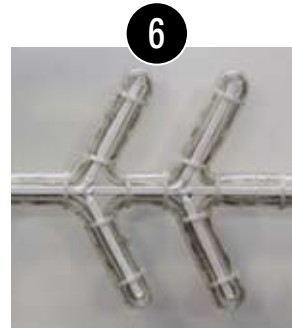
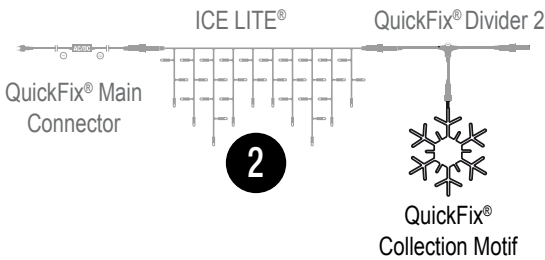
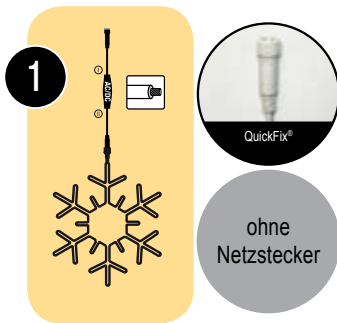

## LED QuickFix® Collection Motif Adapter

Adapter: LED Motiv an QuickFix®  
Adapter ist austauschbar, Jedes QuickFix® Motiv wird mit einem Adapter ausgeliefert.

 244-232  
 244-233

 5  
40



# QuickFix® COLLECTIONS FLEXIBLER MONTAGERAHMEN

Unsere Kleinmotive zur Hängemontage sind mit dem neuen flexiblen Rahmensystem kompatibel. Dadurch können sie als Mast- und Wandmotive eingesetzt werden.

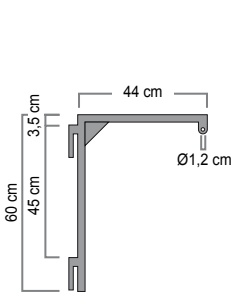

**941-061**

~44 x 60cm

~0.8 kg 

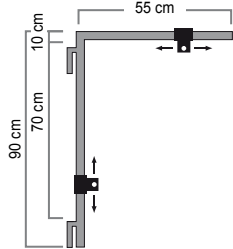

**941-017**

~55 x 90cm

~1 kg 

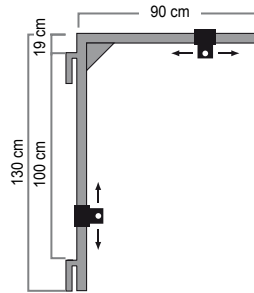

**941-033**

~90 x 130cm

~1.5 kg 

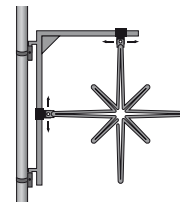
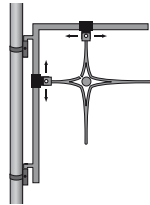
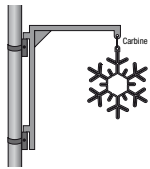

## QuickFix® COLLECTIONS ACCESSORIES 7

### P Mastmontage

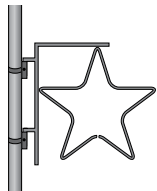

**941-002**

Ø 80 – 100 mm  
Schlauchklemme DIN 3017-AS W4

 10 / 100



**941-006**

Halbschelle

 1 / 30

**941-007**

Halbschelle mit Steckdose

 1 / 30



**941-009**

Edelstahlband  
Länge: 30m

 1

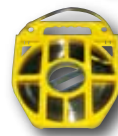

**941-010**

Spange

 25 / 100



**941-011**

Montagewerkzeug

 1



### P Wandmontage

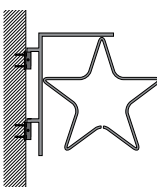

**941-004**

Fassadenschelle

 1

**941-005**

Fassadenschelle mit Steckdose

 1





day & night  
*impressions*

# Collection

Eine Reihe bester zweidimensionaler Lichtmotive für Straßenlaternen, Hausfassaden und Straßenüberspannungen.

Das Sortiment der Collection-Reihe wird laufend durch neue Designideen und Motivgrößen in bewährter MK Qualität erweitert. Bei der Herstellung verwenden wir grundsätzlich neueste LED-Technologie und ab 2011 kombinieren wir sie erstmalig mit – Organic Materials. Die signifikanten Neuerungen dieser Generation sind herausragend und richtungsweisend: 100 Prozent recyclebar, wasser- sowie wetterfest und UV-Licht beständig.

Dazu kommt die neue, kluge Teilintegration des Rahmens in das Motiv, was die Handhabung erleichtert und das Design bereichert, und zwar durch den Tages- und Nachteffekt. Wie das funktioniert? Durch die besondere Materialzusammensetzung entsteht eine sehr reizvolle Oberfläche, die bereits tagsüber bezaubernd schimmert. Nachts werden Engel und Co. durch komplementäre Leuchtmittel aus dem Inneren märchenhaft inszeniert.



einfache Planung – schnelle Umsetzung  
SCHUTZART IP44  
SCHUTZKLASSE 1



COLLECTION  
NORDIC DESIGN

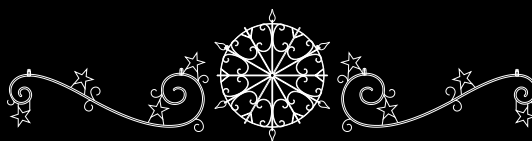

Variation



NORDIC PLAY

	933-945	932-945
↙	~200 x 80cm	~84 x 200cm
◇	~5.5 kg	~6.5 kg
⚡	~37 W	~37 W
🔦	LED	LED
🔧	T-2	P-2
☆	☆	☆



NORDIC WIND WHEEL

	933-946	932-946
↙	~114 x 131cm	~119 x 138cm
◇	~6 kg	~7 kg
⚡	~39 W	~39 W
🔦	LED	LED
🔧	T-2	P-2
☆	☆	☆

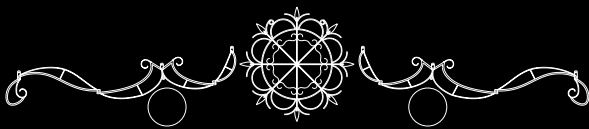

Variation



NORDIC SUN

	933-949	933-950	932-949	932-950
↙	~120 x 120 x 39cm		~124 x 126 x 39cm	
◇	~7.5 kg	~7.5 kg	~9 kg	~9 kg
⚡	~38 W	~38 W	~38 W	~38 W
🔦	LED LED	LED	LED LED	LED
🔧	T-2	T-2	P-2	P-2



932-950



NORDIC LIGHT

	933-947	933-948	932-947	932-948
↙	~244 x 61 x 39cm		~81 x 244 x 39cm	
◇	~6 kg	~6 kg	~7.5 kg	~7.5 kg
⚡	~28 W	~28 W	~28 W	~28 W
🔦	LED	LED	LED	LED
🔧	T-3	T-3	P-2	P-2



COLLECTION  
NORDIC DESIGN

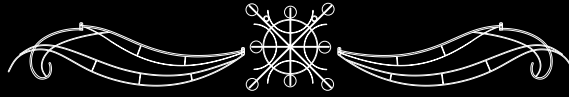

Variation



NORDIC BREEZE

	933-951	933-952
↙	~56 x 241cm	~56 x 241cm
◇	~4 kg	~4 kg
⚡	~19 W	~19 W
🔦	LED LED	LED
🔧	T-2	T-2



NORDIC SPARKLE

	933-953	933-954	932-953	932-954
↙	~80 x 80 x 10cm		~105 x 105 x 10cm	
◇	~3.5 kg	~3.5 kg	~5 kg	~5 kg
⚡	~22 W	~22 W	~22 W	~22 W
🔦	LED LED	LED	LED LED	LED
🔧	T-2	T-2	P-2	P-2



932-953

NORDIC WIND

	932-957	932-958
↙	~100 x 350 x 10cm	
◇	~9.5 kg	~9.5 kg
⚡	~38 W	~38 W
🔦	LED LED	LED
🔧	P-3	P-3





Variation



NORDIC ROSE BUSH

	933-955	932-955
	~342 x 120 x 12cm	~123 x 342 x 12cm
	~10 kg	~12 kg
	~45 W	~45 W
	LED LED	LED LED
	T-4	P-3
	☆	☆

NORDIC ROSE

	933-956	932-956
	~120 x 120 x 12cm	~126 x 124 x 12cm
	~6.5 kg	~7.5 kg
	~41 W	~41 W
	LED LED	LED LED
	T-2	P-2
	☆	☆



CELEBRATION PENTOR

932-932

~98 x 200 x 25cm

~7 kg

~29 W

LED LED

P-2



CELEBRATION BELL

932-933

~120 x 195 x 25cm

~10 kg

~40 W

LED LED

P-2



CELEBRATION COMET

932-934

~88 x 233 x 25cm

~6 kg

~20 W

LED LED

P-2



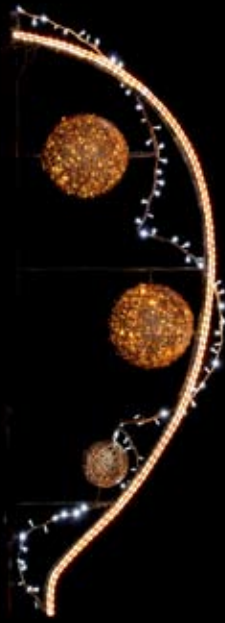

CELEBRATION ARCH

- 932-935**  
 ~99 x 278 x 40cm  
 ~13 kg  
 ~38 W  
 LED LED  
 P-3  
 ☆ 3D



CELEBRATION MOON

- 932-936**  
 ~85 x 163 x 40cm  
 ~5 kg  
 ~19 W  
 LED  
 P-2  
 ☆ 3D



CELEBRATION BOW

- 932-938**  
 ~83 x 215 x 40cm  
 ~8 kg  
 ~27 W  
 LED LED  
 P-2  
 ☆ 3D



CELEBRATION WAVE

- 932-937**  
 ~70 x 174 x 25cm  
 ~5 kg  
 ~13 W  
 LED  
 P-2  
 ☆ 3D



COLLECTION  
COSMIC DREAMS



Variation Organic Meridian



COSMIC WAVE

933-939



~233 x 60 cm



~3 kg



~18 W



LED



T-2



Variation Organic Heart



COSMIC WING

933-940



~240 x 54cm



~3 kg



~19 W



LED



T-2





COSMIC PLANETS

933-941



~593 x 130 x 56cm



~22 kg



~64 W



T-4



COSMIC PLANETS

933-942



~414 x 120 x 41cm



~12 kg



~39 W



T-4



COLLECTION  
SPARKLING CHRISTMAS



SPARKLE PENTOR

932-870

~90 x 245 x 18cm

~8 kg

~43 W

LED LED

P-2



SPARKLE SURPRISE

932-869

~65 x 195 x 35cm

~5 kg

~23 W

LED LED

P-2



SPARKLE WING

932-867

~100 x 245 x 16cm

~9 kg

~58 W

LED LED

P-2



SPARKLE ORIENT

932-868

~127 x 242 x 11cm

~7 kg

~40 W

LED LED

P-3



# COLLECTION SPARKLING CHRISTMAS

motif details  
www.mk-illumination.com/collections



**SPARKLE DECOR**

**932-872**  
~98 x 210 x 25cm  
~8 kg  
~58 W  
LED LED  
P-2  
☆ 3D



**SPARKLE ARCH**

**932-871**  
~47 x 190 x 25cm  
~5 kg  
~31 W  
LED  
P-2  
☆ 3D



**SPARKLE RISE**

**932-874**  
~65 x 205 x 16cm  
~7 kg  
~48 W  
LED  
P-2  
☆ 3D

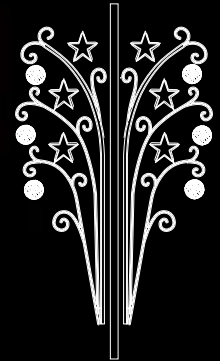

**ANGEL IN LOVE**

**932-873**  
~118 x 217cm  
~8 kg  
~50 W  
LED LED LED  
P-2  
☆



COLLECTION  
SYMPHONIA



VIOLIN

932-875

~ 104 x 237cm



~8 kg

~58 W

LED LED

P-2



HARP

932-876

~ 113 x 230cm



~7 kg

~34 W

LED LED

P-2



TANGO

932-877

~ 135 x 250cm



~6 kg

~25 W

LED LED

P-2



max. Ø  
~ 80 cm



A sketch of your lamp is required when ordering



FLAMENCO

932-878

~ 94 x 246cm



~7 kg

~46 W

LED LED

P-2

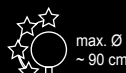

max. Ø  
~ 90 cm



A sketch of your lamp is required when ordering



WALTZ

932-879

~ 125 x 166cm



~5 kg

~31 W

LED LED

P-2



max. Ø  
~ 50 cm



A sketch of your lamp is required when ordering



JAZZ DANCE

933-880

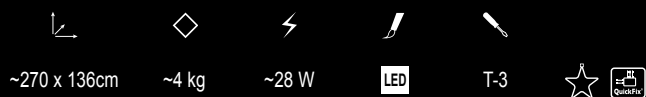

~270 x 136cm

~4 kg

~28 W

LED

T-3



Variation Classic Flake



PIANO DANCE

933-881



~263 x 91cm

~5 kg

~37 W

LED

T-2

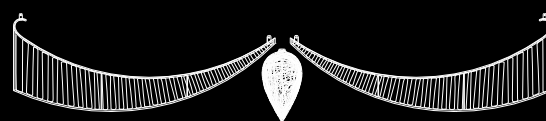

Variation Fir Cone



BAROQUE QUINTET

933-883

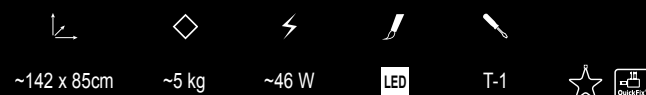

~142 x 85cm

~5 kg

~46 W

LED

T-1

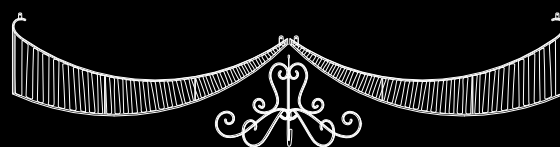

COLLECTION  
SWING



Variation Fir Cone

SWING GLAMOUR

933-886



~ 219 x 64cm

~5 kg

~28 W

LED

T-2



SWING BAROQUE

933-885



~280 x 64cm

~6 kg

~41 W

LED LED

T-2



Variation Pentor



SWING DUET

933-884



~270 x 44cm

~7 kg

~57 W

LED LED

T-2



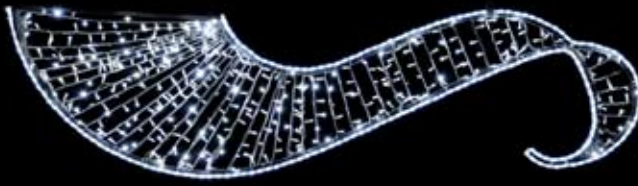

SWING SKY

933-887



~255 x 75cm



~5 kg



~45 W



LED



T-2



Variation Christmas Bauble



SWING WAVE

933-888



~255 x 63cm



~3 kg



~23 W



LED



T-2



SWING ANGEL

933-889



~ 425 x 145 x 50cm



~20 kg



~115 W



LED LED



T-4



3D



COLLECTION  
ICE TWIG

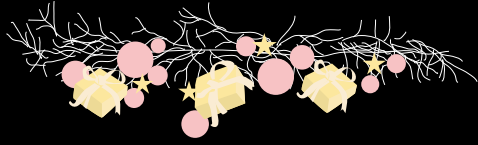

Variation Christmas Bauble + Parcels

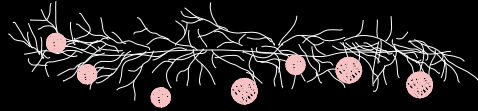

Variation Christmas Bauble



ICE TWIG 2

933-891



~ 340 x 80 x 90cm



~17 kg



~78 W



LED



T-2



3D



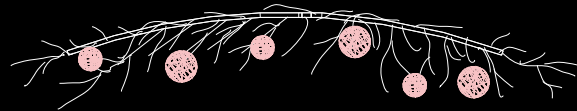

Variation Christmas Bauble



ICE TWIG 1

933-890



~ 420 x 90 x 100cm

~20 kg

~91 W



T-3



COLLECTION  
DECO TWIG

indoor only



SPARKLING TWIG

**933-893**  
~98 x 88 x 58cm  
~7 kg  
~17 W  
LED LED  
T-1  
☆ 3D



RIBBON TWIG

**933-894**  
~ 85 x 78 x 58cm  
~6 kg  
~17 W  
LED LED  
T-1  
☆ 3D



DAISY TWIG

**933-895**  
~ 110 x 280 x 70cm  
~15 kg  
~59 W  
LED  
T-1  
☆ 3D



POLE TWIG 1 TWIG

**932-897**

~ 87 x 100 x 45cm

~6 kg

~24 W

LED

P-2



POLE TWIG 2

**932-898**

~ 70 x 160 x 40cm

~10 kg

~39 W

LED LED

P-2



POLE TWIG 3

**932-929**

~100 x 125 x 50cm

~7 kg

~22 W

LED

P-2





CHRISTMAS BELL

933-899



~ 250 x 93cm

~10 kg

~60 W



T-2



Variation Pentor



CHRISTMAS DUET

933-900



~ 270 x 50cm

~6 kg

~34 W



T-2



Variation Organic Heart

CHRISTMAS RIBBON

933-901



~ 270 x 48cm

~4 kg

~16 W



T-3





CHRISTMAS GARLAND 2

933-905



~ 201 x 63cm

~6 kg

~34 W

LED LED

T-2



CHRISTMAS GARLAND 1

933-904



~ 230 x 63cm

~7 kg

~42 W

LED LED

T-2



CHRISTMAS STAR

933-902

~ 234 x 70cm

~5 kg

~32 W

LED

T-3



CHRISTMAS BALL GRID

933-903



~ 512 x 125cm

~15 kg

~89 W

LED LED

T-4



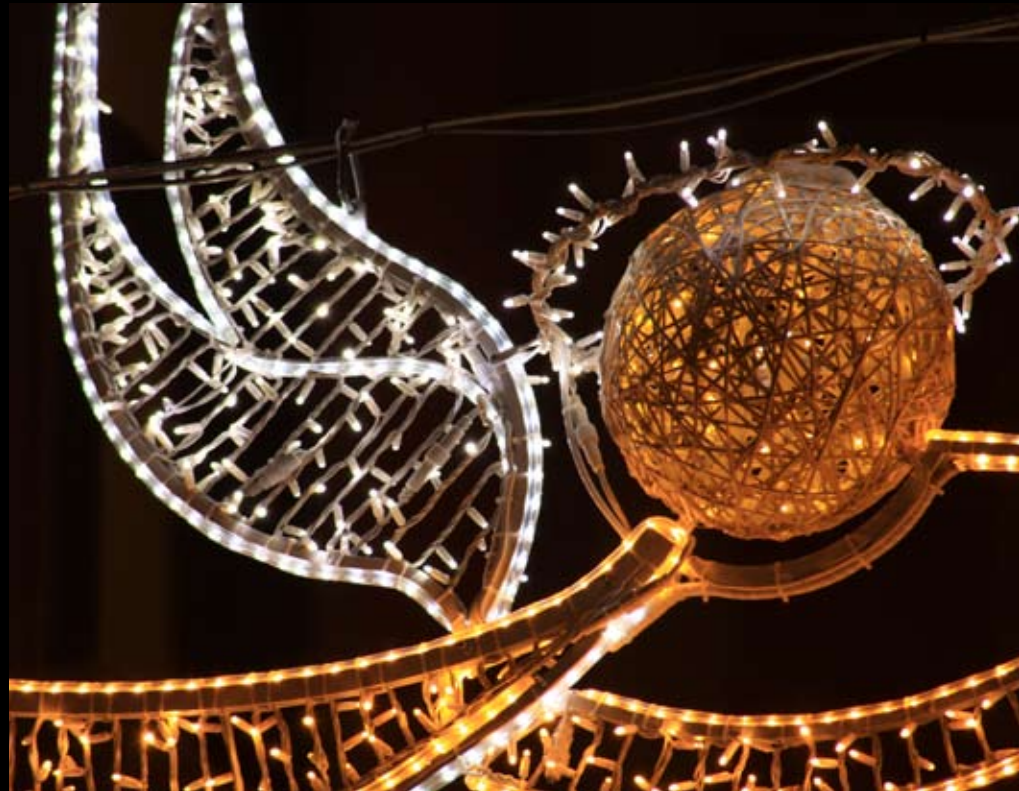

# *Collections*



COLLECTION  
GLITTERING POLES



GLITTERING BELL

**932-906**

~ 93 x 250cm



~13 kg



~54 W



LED    



P-2



GLITTERING EVE

**932-907**

~ 85 x 225cm



~8 kg



~36 W



LED    



P-2



GLITTERING STAR

**932-908**

~ 70 x 234cm



~6 kg



~32 W



LED    



P-2



GLITTERING ROMANCE

**932-909**

~ 135 x 133cm



~6 kg



~49 W



LED      



P-2



motif details  
[www.mk-illumination.com/collections](http://www.mk-illumination.com/collections)



GLITTERING CONE

- 932-910**  
~ 83 x 355 cm  
~8 kg  
~30 W  
LED P-3  
★



GLITTERING TREE

- 932-911**  
~ 70 x 236cm  
~10 kg  
~24 W  
LED P-2  
★



GLITTERING NOEL

- 932-912**  
~ 105 x 227cm  
~6 kg  
~29 W  
LED P-2  
★



COLLECTION  
POLE ORNAMENTS



ORNAMENT WIZZARD

**932-915**  
~ 104 x 237cm  
~8 kg  
~34 W  
**LED**  
P-2  
☆



ORNAMENT MEDAL

**932-913**  
~ 81 x 262 x 40cm  
~7 kg  
~43 W  
**LED**  
P-2  
☆ 3D



ORNAMENT PENTOR

**932-914**  
~ 60 x 246cm  
~6 kg  
~22 W  
**LED LED**  
P-2  
☆



ORNAMENT PARCEL

**932-916**  
~ 107 x 300cm  
~11 kg  
~55 W  
**LED LED**  
P-3  
☆



ORNAMENT BAUBLE

**932-921**

~ 62 x 195cm



~7 kg



~28 W



LED 

P-2



ORNAMENT BALANCE

**932-920**

~ 65 x 146cm



~9 kg



~26 W



LED 

P-2



ORNAMENT CONIC

**932-919**

~ 78 x 189cm



~6 kg



~22 W



LED  LED 

P-2



ORNAMENT TREE

**932-922**

~ 64 x 194cm



~7 kg



~38 W



LED 

P-2



COLLECTION  
HARMONY



HARMONY LIGHT

**932-925**

~ 80 x 154cm



~8 kg



~35 W



LED



P-2



HARMONY ORIENTAL

**932-924**

~ 114 x 230cm



~13 kg



~57 W



LED



P-3



HARMONY PENTOR

**932-923**

~ 90 x 313cm



~10 kg



~51 W



LED



P-3





HARMONY RIBBON

**932-926**

~ 120 x 160cm

~6 kg

~37 W

LED

P-2



HARMONY ICE ART

**932-927**

~ 134 x 290cm

~11 kg

~58 W

LED

P-3



HARMONY HOLLY

**932-928**

~ 65 x 145cm

~7 kg

~25 W

LED

P-2



COLLECTION  
ASTERO

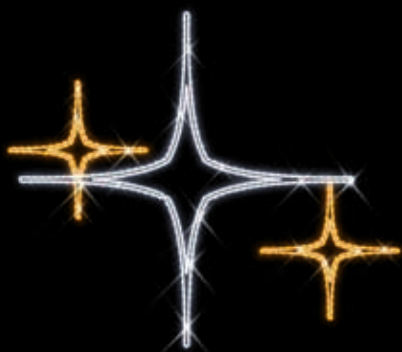

ASTERO SPACE

	933-762	933-763
↙	~185 x 155cm	~185 x 155cm
◇	~6 kg	~6 kg
⚡	~34 W	~34 W
✂	LED LED	LED LED
🔧	T-3	T-3



ASTERO POLE

	932-439	932-726
↙	~135 x 225cm	~135 x 225cm
◇	~10 kg	~10 kg
⚡	~60 W	~60 W
✂	LED LED	LED LED
🔧	P-3	P-3



ASTERO SKY

	933-917	↙	◇	⚡	✂	🔧	☆
	~480 x 160cm	~23 kg	~94 W	LED LED	T-3	☆	
	933-918	~480 x 160cm	~23 kg	~94 W	LED LED	T-3	☆



ELVES TWIG 2

	932-765	932-766
↙	~60 x 255 x 12cm	~60 x 255 x 12cm
◇	~7 kg	~7 kg
⚡	~30 W	~30 W
🔪	LED	LED
🔪	P-3	P-3



ELVES TWIG

	932-764	932-838
↙	~120 x 245 x 12cm	~120 x 245 x 12cm
◇	~7 kg	~7 kg
⚡	~41 W	~41 W
🔪	LED	LED
🔪	P-3	P-3



ELVES BRANCH

	933-764	↙	◇	⚡	🔪	🔪	☆
	~490 x 95 x 12cm	~12.5 kg	~65 W	LED	T-3	☆	
	933-765	~490 x 95 x 12cm	~12.5 kg	~65 W	LED	T-3	☆



# *Collections*



COLLECTION  
PEGASUS



AURIGA STAR POLE

932-767

~95 x 220cm

~7.5 kg

~30 W

LED LED

P-2

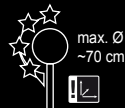

A sketch of your lamp is required when ordering



PEGASUS POLE

932-770

~95 x 185cm

~5.5 kg

~28 W

LED LED

P-2



932-841

~95 x 185cm

~5.5 kg

~28 W

LED LED

P-2



A sketch of your lamp is required when ordering



PEGASUS SKY

933-716



~525 x 140cm



~22 kg



~128 W



LED LED



T-3



933-530

~525 x 140cm

~22 kg

~128 W

LED LED

T-3



PEGASUS MAST

932-842



~125 x 290cm

~13 kg

~82 W

LED LED

P-3

932-843

~125 x 290cm

~13 kg

~82 W

LED LED

P-3





ICE 2

	933-803	933-556
↙	~70 x 300cm	~70 x 300cm
◇	~9 kg	~9 kg
⚡	~42 W	~42 W
✂	LED LED	LED LED
🔪	T-2	T-2



ICE 3

	933-802	933-842
↙	~60 x 175cm	~60 x 175cm
◇	~6 kg	~6 kg
⚡	~29 W	~29 W
✂	LED LED	LED LED
🔪	T-2	T-2

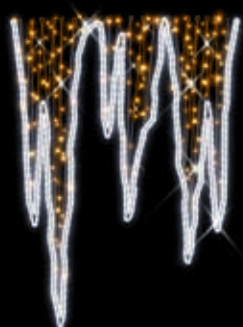

ICE 1

	933-779	↙	◇	⚡	✂	🔪	☆
	~110 x 145cm	~8.5 kg	~59 W	LED LED	T-2	☆	
	933-555	~110 x 145cm	~8.5 kg	~59 W	LED LED	T-2	☆

COLLECTION  
FROSTY

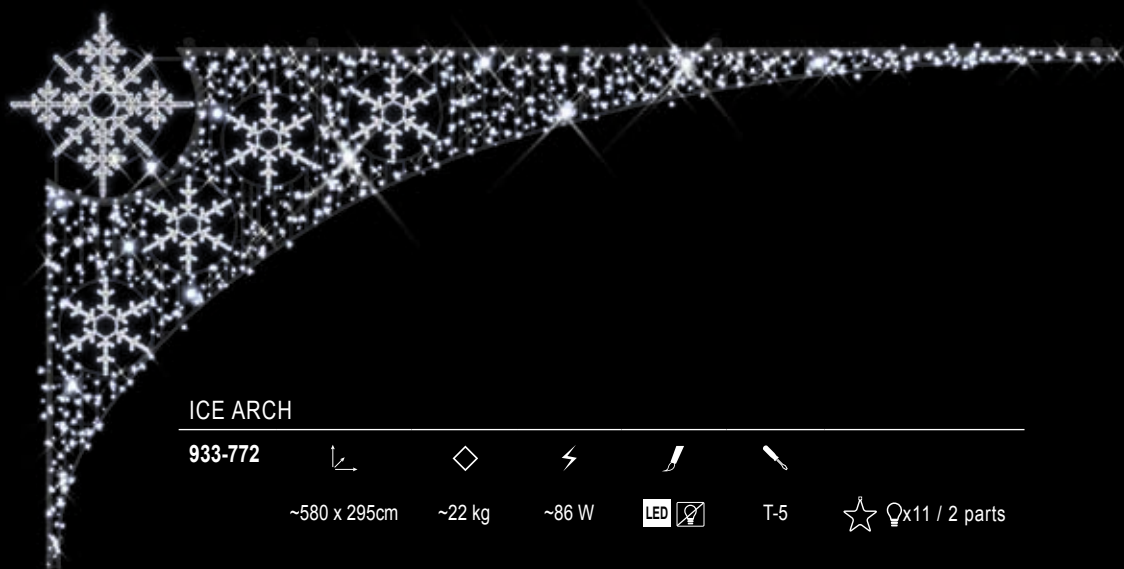

ICE ARCH

933-772



~580 x 295cm

~22 kg

~86 W



T-5

☆ Qx11 / 2 parts





ICE TWIG

933-838

~580 x 150cm    ~21 kg    ~60 W    LED    T-8    ☆ 3D

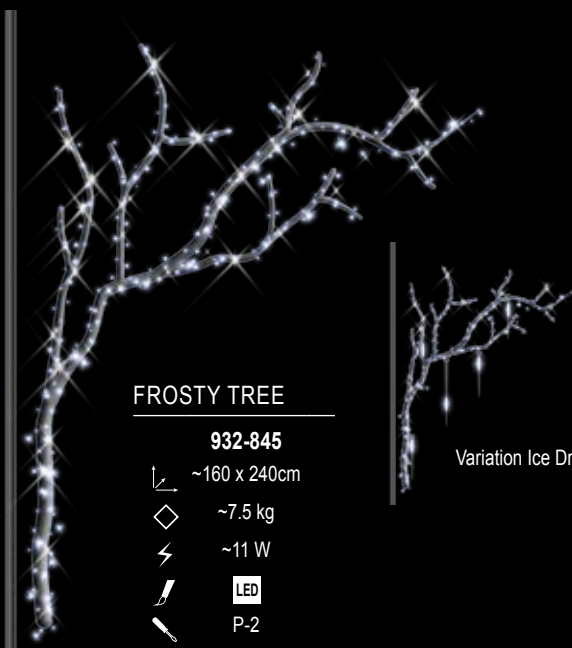

FROSTY TREE

932-845

~160 x 240cm  
~7.5 kg  
~11 W  
LED  
P-2  
☆

Variation Ice Drop

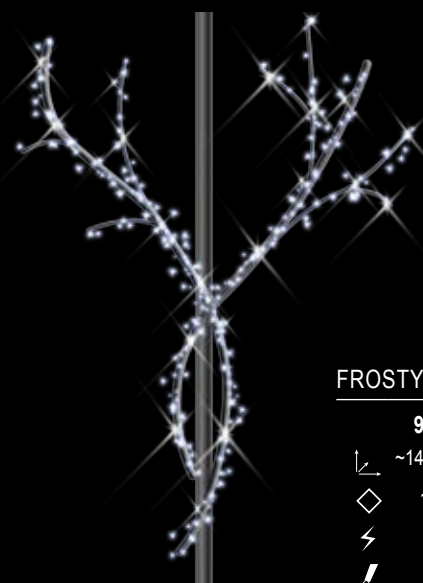

FROSTY BRANCH

932-628

~145 x 205cm  
~6.5 kg  
~11 W  
LED  
P-2  
☆

# COLLECTION POLARIS



## POLARIS MAST

**932-782**

~120 x 215cm  
 ~8 kg  
 ~45 W  
 LED LED  
 P-2  
 max. Ø ~70 cm  
 A sketch of your lamp is required when ordering



## POLARIS POLE

**933-756**

**933-848**

**932-756**

**932-848**

~98 x 200cm ~98 x 200cm ~98 x 200cm ~98 x 200cm  
 ~9 kg ~9 kg ~9 kg ~9 kg  
 ~33 W ~33 W ~33 W ~33 W  
 LED LED LED LED  
 T-2 T-2 P-2 P-1-2  
 A sketch of your lamp is required when ordering



## POLARIS CROWN POLE

**932-849**

~146 x 195cm  
 ~7.5 kg  
 ~48 W  
 LED  
 P-2  
 max. Ø ~80 cm  
 A sketch of your lamp is required when ordering



## POLARIS SKY

**933-775**

~400 x 135cm ~16 kg ~118 W LED LED T-3

**933-863**

~400 x 135cm ~16 kg ~118 W LED T-3



## POLARIS CROWN

**932-850**

~140 x 85 x 140cm  
 ~10.5 kg  
 ~64 W  
 LED  
 P-4  
 max. Ø ~80 cm  
 A sketch of your lamp is required when ordering



CASSIOPEIA MAST

932-773

~145 x 260 cm

~10 kg

~73 W

LED LED

P-2



CASSIOPEIA POLE

932-844

~110 x 250cm

~5.5 kg

~31 W

LED LED

P-2



A sketch of your lamp is required when ordering



COMET

932-826

~140 x 105cm

~4 kg

~35 W

LED

P-2



CASSIOPEIA SKY

933-769

~515 x 140cm

~18.5 kg

~90 W

LED LED

T-3



COLLECTION  
LIGHT ARCH LIBERA

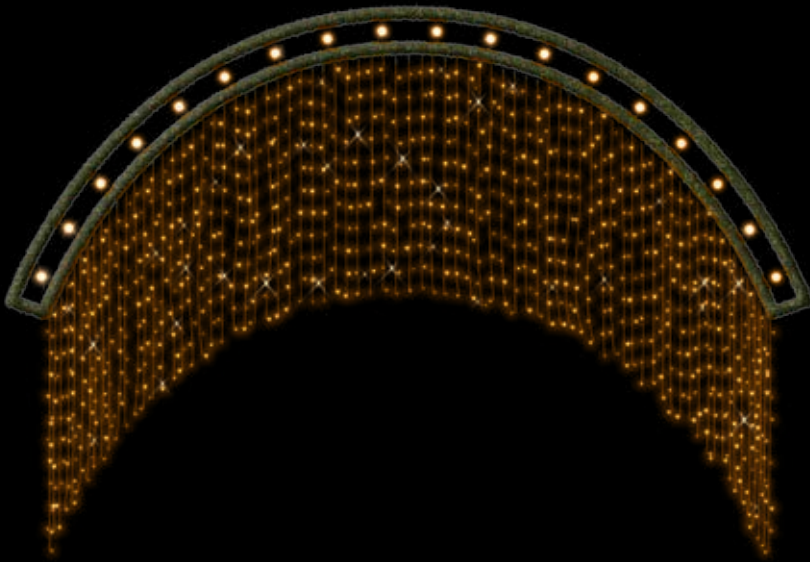

LIBERA ARCH

<b>933-777</b>						
	~455 x 465cm	~27 kg	~99 W		T-5	☆  x18
<b>933-778</b>						
	~455 x 315cm	~24 kg	~80 W		T-5	☆  x18

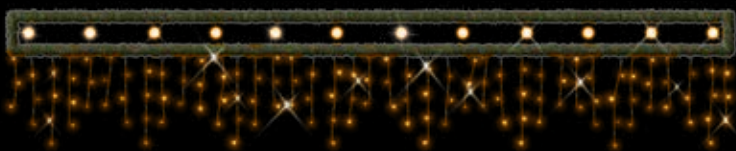

LIBERA SKY

<b>933-776</b>						
	~400 x 80cm	~12 kg	~10 W		T-3	☆  x12

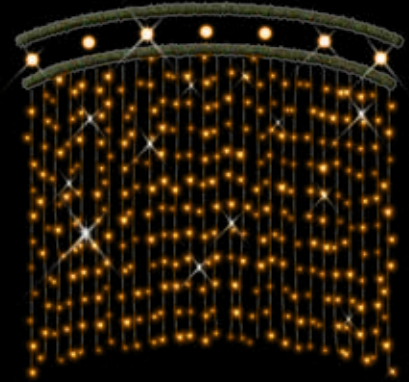

LIBERA BOW

<b>933-835</b>						
	~198 x 190cm	~7.5 kg	~28 W		T-2	☆  x7



LIBERA MAST

<b>933-851</b>						
	~100 x 200cm	~5 kg	~14 W		T-2	☆  x4
<b>932-851</b>						
	~96 x 173cm	~5 kg	~14 W		P-2	☆  x4



COLLECTION  
BOA



BOA TWIG

**932-836**

~65 x 165 x 17cm

~5.5 kg

~21 W

LED

P-2



Variation Organic Ball



BOA TWIG

**933-836**

~165 x 65 17cm

~5.5 kg

~21 W

LED

T-2



BOA ANGEL

**933-583**

~270 x 285 x 10cm

~21 kg

~126 W

LED

T-2





ASTERO CROWN

932-854

~122 x 185 x 122cm

~24.5 kg

~74 W

LED LED

P-4

3D



max. Ø  
~80 cm  
A sketch of your lamp is required when ordering



PENTOR CROWN

932-635

~122 x 185 x 122cm

~25.5 kg

~78 W

LED LED

P-4

3D

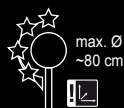

max. Ø  
~80 cm  
A sketch of your lamp is required when ordering



RISING SNOW CRYSTAL

932-856

~186 x 220 x 186cm

~36 kg

~173 W

LED

P-4

3D



max. Ø  
~100 cm  
A sketch of your lamp is required when ordering



COMET WEGA

932-790

~110 x 115cm

~3 kg

~17 W

LED

P-2

3D





# *Collections*



COLLECTION  
DRAPE LIGHT

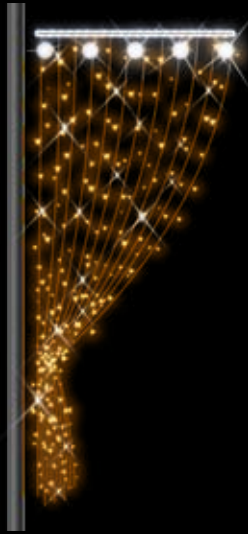

DRAPE SWING

	<b>932-776</b>	<b>932-860</b>
	~95 x 190cm	~95 x 190cm
	~6 kg	~6 kg
	~14 W	~14 W
	P-2	P-2
	x5	x5

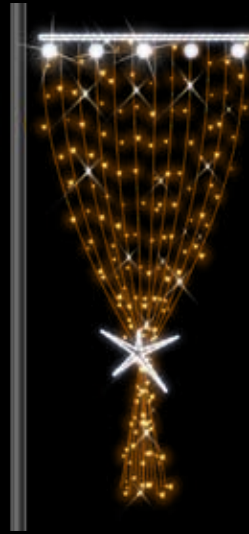

DRAPE ASTERO

	<b>932-775</b>	<b>932-572</b>
	~95 x 195cm	~95 x 195cm
	~7.5 kg	~7.5 kg
	~18 W	~18 W
	P-2	P-2
	x5	x5



CANDELINO

	<b>932-959</b>
	~130 x 290 x 130cm
	~16 kg
	~58 W
	P-4
	max. Ø ~70 cm
	A sketch of your lamp is required when ordering



ARUNDINO

	<b>932-960</b>
	~130 x 160 x 130cm
	~13 kg
	~35 W
	P-4
	max. Ø ~70 cm
	A sketch of your lamp is required when ordering

motif details  
[www.mk-illumination.com/collections](http://www.mk-illumination.com/collections)

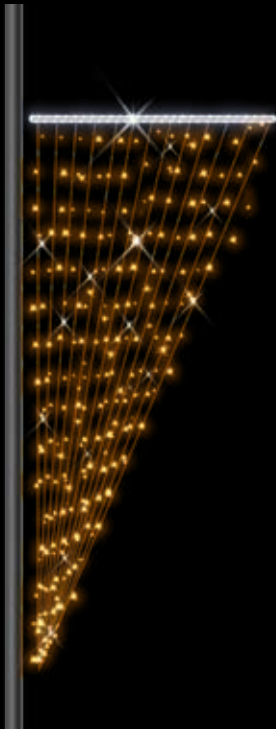

DRAPE CLASSIC

	932-792	932-569
↙	~90 x 210cm	~90 x 210cm
◇	~6.5 kg	~6.5 kg
⚡	~9 W	~9 W
✂	LED LED	LED LED
✂	P-2	P-2

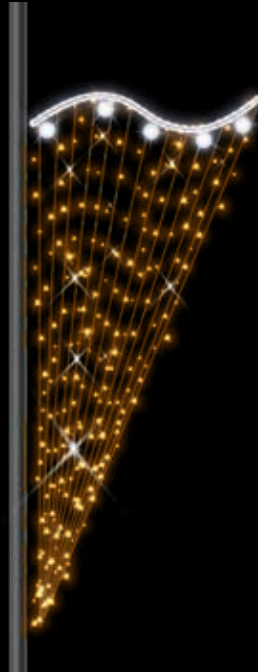

DRAPE WAVE

	932-793	932-570
↙	~90 x 210cm	~90 x 210cm
◇	~6 kg	~6 kg
⚡	~13 W	~13 W
✂	LED LED ✎	LED LED ✎
✂	P-2	P-2

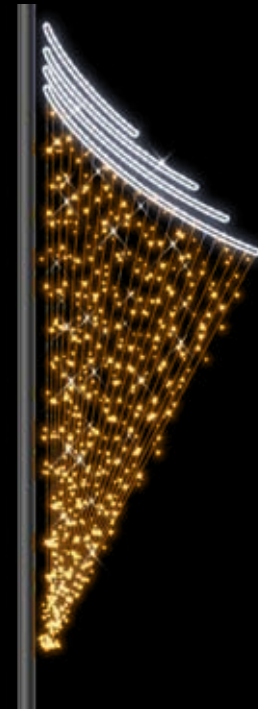

DRAPE SAIL

	932-730	932-863
↙	~85 x 235cm	~85 x 235cm
◇	~8 kg	~8 kg
⚡	~22 W	~22 W
✂	LED LED	LED LED
✂	P-2	P-2



COLLECTION  
DRAPE LIGHT

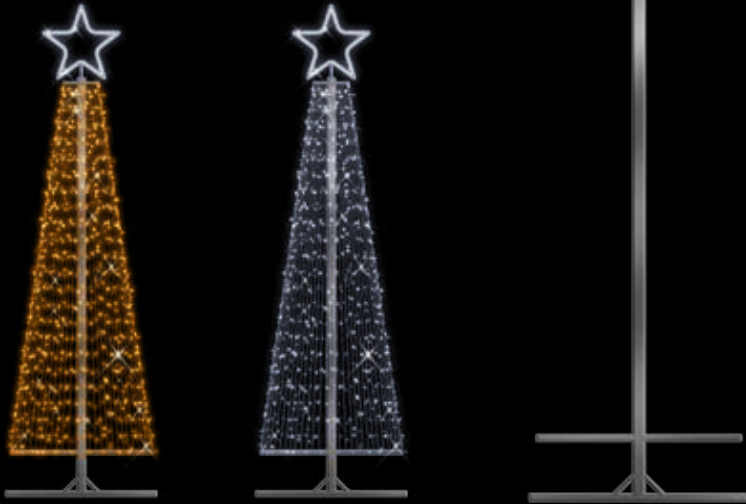

DRAPE TREE

933-860

~120 x 400 x 120 cm

~30 kg

~18 W

LED

3D Self Standing  
without Drape Lite®

DRAPE TREE + 2 X LED DRAPE LITE® 600

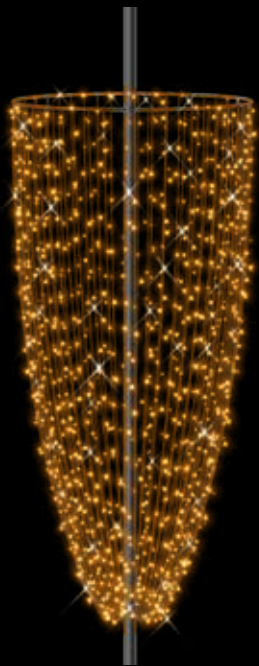

DRAPE CANDELINO

932-961 932-962

~130 x 270 x 130cm

~17 kg ~17 kg

~58 W ~58 W

LED

LED

P-4

P-4



A sketch of your  
lamp is required  
when ordering



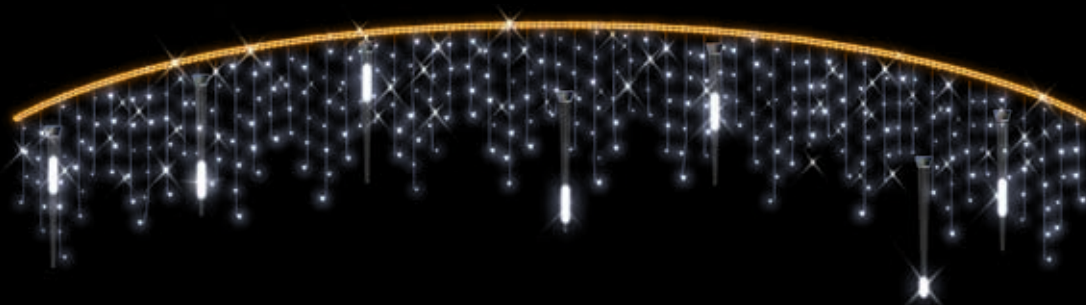

ARCH ICE DROP

933-773



~575 x 150cm

~18.5 kg

~71 W

LED LED

T-3



WINTER FLAKE

933-817

932-817



Ø ~135cm

~140 x 135cm



~7.5 kg

~9 kg



~64 W

~64 W



LED

LED



T-2

P-2



COLLECTION  
DRAPE LIGHT

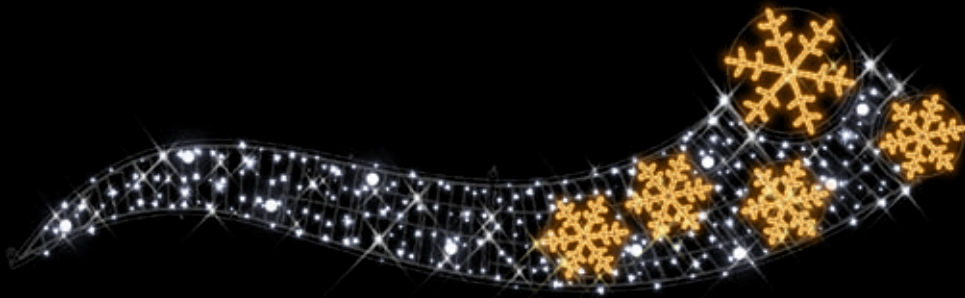

NORTHWIND

933-632



~489 x 146cm

~24 kg

~70 W



T-3





ANGELINO

	933-760	932-760
	~135 x 153cm	~135 x 153cm
	~8 kg	~8 kg
	~60 W	~60 W
	LED	LED
	T-2	P-2
	☆	☆



CANDLE

	933-787
	~16 x 56cm
	~1 kg
	~6 W
	LED
	T-2
	☆



TRUMPET

	933-944
	~40 x 40cm
	~1 kg
	~3 W
	LED
	T-2
	☆



HARP

	933-788
	~35 x 50cm
	~1.5 kg
	~12 W
	LED
	T-2
	☆

COLLECTION  
CHRISTMAS TALES



SANTA'S TRAIN

933-897



~290 x 145cm

~25.5 kg

~202 W

LED LED LED LED

T-2



SANTA'S WAGON

933-898



~125 x 145cm

~12 kg

~90 W

LED LED LED LED

T-2



REINDEER

933-783



~205 x 160cm

~26 kg

~93 W

LED LED

T-2



SANTA SLEDGE

933-784



~230 x 175cm

~17.5 kg

~133 W

LED LED LED LED

T-2



# COLLECTION CHRISTMAS TALES

motif details

[www.mk-illumination.com/collections](http://www.mk-illumination.com/collections)

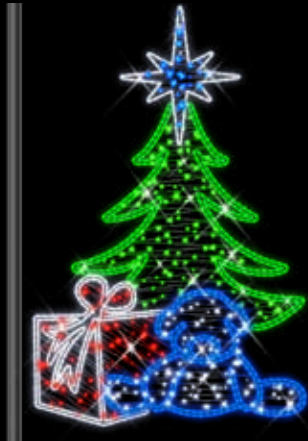

## BLUE TEDDY

933-625



~135 x 210cm

~13.5 kg

~101 W



T-1



932-625

~140 x 210cm

~15.5 kg

~101 W



P-3



## GLITTER SKY

933-825



~320 x 165cm

~21 kg

~168 W



T-3



## GLITTER POLE

932-865



~160 x 155cm



~12 kg



~92 W



P-2



Chr min. 45cm

Merry Christmas

TYPE 2

Merry Christmas

TYPE 3

Merry Christmas

TYPE 4

Merry Christmas

TYPE 5

Merry Christmas

TYPE 6

*Merry Christmas*

TYPE 7

Merry Christmas

TYPE 8

Merry Christmas

TYPE 9

 WHITE DAYS



Variations

Standard



Bulbs



Bulbs &  
String Lite®

String Lite®



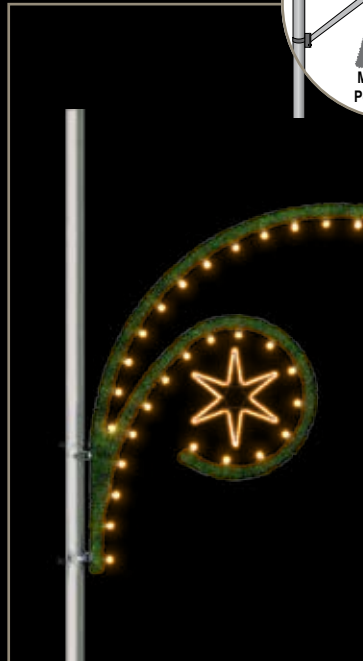
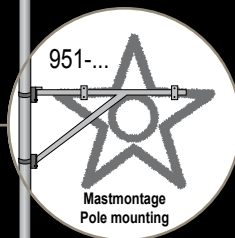
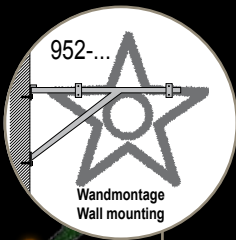

	951-019	954-019
▵	140 x 320cm	140 x 320cm
◇	9.00 kg	9.00 kg
💡 E27	24	24
⚡	<input checked="" type="checkbox"/>	<input checked="" type="checkbox"/>
☆	<input checked="" type="checkbox"/>	<input checked="" type="checkbox"/>

	951-012	952-012	954-012
▵	180 x 310cm	180 x 310cm	180 x 310cm
◇	12.00 kg	12.00 kg	12.00 kg
💡 E27	57	57	57
⚡	<input checked="" type="checkbox"/>	<input checked="" type="checkbox"/>	<input checked="" type="checkbox"/>
☆	<input checked="" type="checkbox"/>	<input checked="" type="checkbox"/>	<input checked="" type="checkbox"/>

	951-013	952-013	954-013
▵	130 x 280cm	130 x 280cm	130 x 280cm
◇	11.50 kg	11.50 kg	11.50 kg
💡 E27	29	29	29
⚡	<input checked="" type="checkbox"/>	<input checked="" type="checkbox"/>	<input checked="" type="checkbox"/>
☆	<input checked="" type="checkbox"/>	<input checked="" type="checkbox"/>	<input checked="" type="checkbox"/>

Bulbs: 61-63



	951-021	952-021	953-021	954-021
▵	130 x 80cm	130 x 80cm	130 x 80cm	130 x 80cm
◇	3.20 kg	3.20 kg	3.20 kg	3.20 kg
💡 E27	20	20	20	20
⚡	<input checked="" type="checkbox"/>	<input checked="" type="checkbox"/>	<input checked="" type="checkbox"/>	<input checked="" type="checkbox"/>
☆	<input checked="" type="checkbox"/>	<input checked="" type="checkbox"/>	<input checked="" type="checkbox"/>	<input checked="" type="checkbox"/>



	951-007	952-007	954-007
▵	130 x 260cm	130 x 260cm	130 x 260cm
◇	10.50 kg	10.50 kg	10.50 kg
💡 E27	34	34	34
⚡	<input checked="" type="checkbox"/>	<input checked="" type="checkbox"/>	<input checked="" type="checkbox"/>
☆	<input checked="" type="checkbox"/>	<input checked="" type="checkbox"/>	<input checked="" type="checkbox"/>

	951-014	952-014	954-014
▵	75 x 140cm	75 x 140cm	75 x 140cm
◇	4.80 kg	4.80 kg	4.80 kg
💡 E27	20	20	20
⚡	<input checked="" type="checkbox"/>	<input checked="" type="checkbox"/>	<input checked="" type="checkbox"/>
☆	<input checked="" type="checkbox"/>	<input checked="" type="checkbox"/>	<input checked="" type="checkbox"/>

COLLECTION  
CLASSIC

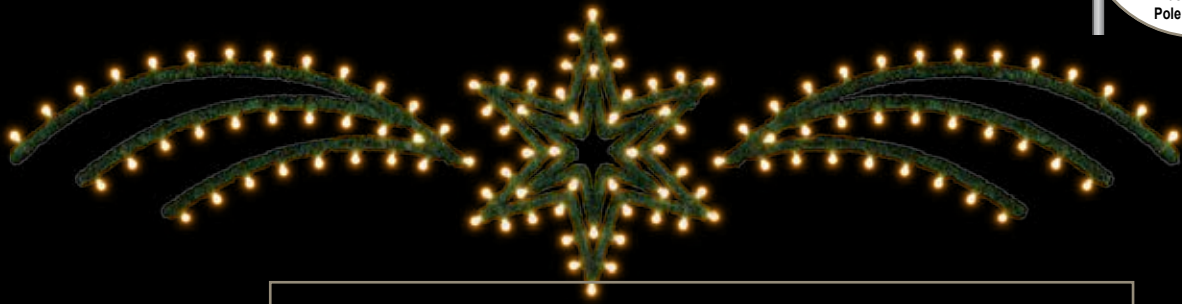
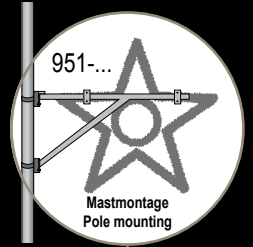

<b>953-008</b>			⚡ E27			
	860 x 160cm	21.00 kg	112			
<b>954-008</b>						
	860 x 160cm	21.00 kg	112			



<b>953-020</b>			⚡ E27			
	600 x 160cm	25.00 kg	114			
<b>954-020</b>						
	600 x 160cm	25.00 kg	114			



<b>953-010</b>			⚡ E27			
	940 x 185cm		128			
<b>954-010</b>						
	940 x 185cm		128			

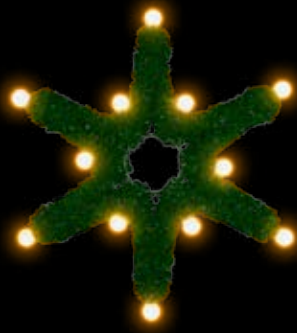

951-001 952-001 953-001 954-001

↙	65 x 70cm	65 x 70cm	65 x 70cm	65 x 70cm
◇	2.00 kg	2.00 kg	2.00 kg	2.00 kg
💡 E27	12	12	12	12
⚡	☑	☑	☑	☑



951-005 952-005 953-005 954-005

↙	145 x 130cm		145 x 130cm	
◇	4.90 kg	4.90 kg	4.90 kg	4.90 kg
💡 E27	36	36	36	36
⚡	☑	☑	☑	☑



951-016 952-016 954-016

↙	100 x 70cm	100 x 70cm	100 x 70cm
◇	7.30 kg	7.30 kg	7.30 kg
💡 E27	11	11	11
⚡	☑	☑	☑

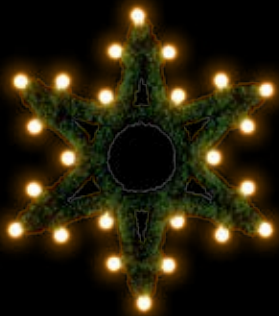

951-003 952-003 953-003 954-003

↙	85 x 95cm		85 x 95cm	
◇	2.90 kg	2.90 kg	2.90 kg	2.90 kg
💡 E27	24	24	24	24
⚡	☑	☑	☑	☑



951-002 952-002 953-002 954-002

↙	90 x 90cm		90 x 90cm	
◇	2.80 kg	2.80 kg	2.80 kg	2.80 kg
💡 E27	20	20	20	20
⚡	☑	☑	☑	☑



951-015 952-015 954-015

↙	90 x 85cm		90 x 85cm	
◇	3.50 kg	3.50 kg	3.50 kg	3.50 kg
💡 E27	20	20	20	20
⚡	☑	☑	☑	☑



## FilaLED

### LED FilaLED BALL E27

Tropfenformlampe, LED: 1, 220-240 V AC, 2,2 W  
2.4 VA

LED 015-024

LED 015-025



### LED FilaLED PEAR E27

Birnenformlampe, LED: 1, 220-240 V AC, 2,2 W  
2.4 VA

LED 015-026

LED 015-027



## Golf Ball

### LED GOLF BALL E27

Tropfenformlampe, LED: 12, 220-240 V AC, 1,5 W  
5 VA

LED 014-106

LED 014-100

LED 014-107



## Deco Golf Ball

### LED DECO GOLF BALL E27

Tropfenformlampe, LED: 7, 220-240 V AC, 1 W  
5 VA

LED 015-078

LED 015-079

LED 015-080

LED 015-081





# ACCESSORIES COLLECTIONS

## Steckmontage – Fest verbundener Rahmen

**P** Steckmontage auf Wand oder Laternen

**2** Befestigungspunkte: 2

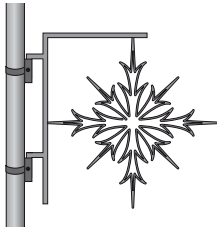

**P** Steckmontage auf Wand oder Laternen

**3** Befestigungspunkte: 3

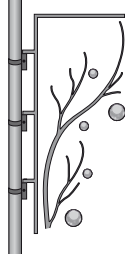

**P** Steckmontage auf Wand oder Laternen

**4** Befestigungspunkte: 4

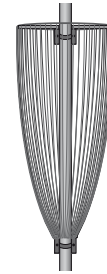

### **P** Mastmontage

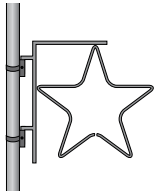

**941-002**  
Ø 80 - 100 mm  
Schlauchklemme DIN 3017-AS W4



**941-006**  
Halbschelle



**941-007**  
Halbschelle mit Steckdose



**941-009**  
Edelstahlband  
Länge: 30m

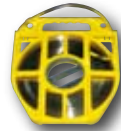

**941-010**  
Spange



**941-003**  
Ø 100 - 120 mm  
Schlauchklemme DIN 3017-AS W4



**941-011**  
Montagewerkzeug



### **P** Wandmontage

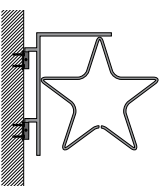

**941-004**  
Fassadenschelle



**941-005**  
Fassadenschelle mit Steckdose





# ACCESSORIES COLLECTIONS

## Hängemontage

T Hängemontage

2 Befestigungspunkte: 2

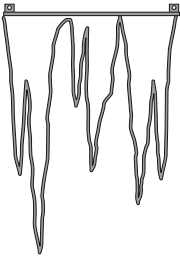

T Hängemontage

3 Befestigungspunkte: 3

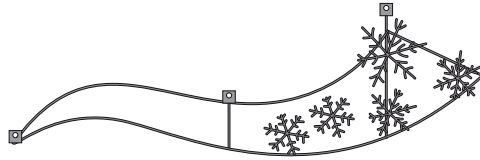

### GRIPPLE

**941-027**

Straßenüberspannungs-Set  
Ø 0.4 x 1000cm



**941-028**

Straßenüberspannungs-Set  
Ø 0.4 x 2000cm

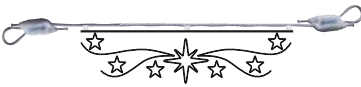

**941-019**

Abhänge-Set Gripple  
inkl. Stahlseil 10m



**941-026**

Abhänge-Set Gripple  
inkl. Stahlseil 3m

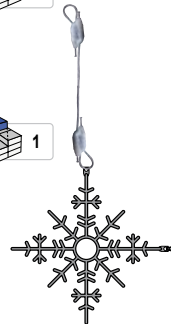

**Seilspannzange**

**941-029**





# Limited

## by MK Illumination

### Conceptual festive lighting

Mit der Liebe zum Detail und exklusiver Handwerkskunst entstehen Unikate mit höchstem Designanspruch: die Limited Serie.

Ideenreichtum formt das Werk zum Spitzenprodukt; es wird zum „Piece of the Art“, ein Einzelstück – stimmungsvoll und besonderen Ansprüchen gerecht. Seit 2009 arbeiten wir in unsere dreidimensionalen Lichtmotive für Innen und Außen edle Kristalltropfen und -perlen ein. Dabei entstehen echte Schmuckstücke, die bei unseren Kunden sehr beliebt sind. Grund genug, für diese exklusive Reihe weiterhin intensiv nach neuen Möglichkeiten zu suchen. Gefunden wurden sie beispielsweise in den stilistischen Richtungen „Glory“ (die Glamourösen) und „Joy“ (die Verspielten).



Cavendish Square, South Africa



Sanderson Arcade, UK



Eurovea Shopping Center, Slovakia



Panora, Turkey



Cavendish Square, South Africa



River Park, Slovakia



Shopping Arena St. Gallen, Switzerland



Eurovea Shopping Center, Slovakia



Eurovea Shopping Center, Slovakia



Renoma, Poland



Shopyland Schönbühl, Switzerland



Stockmann, Finland



Cavendish Square, South Africa



Liffey Valley, Ireland

# Artificial Tree

Artificial Tree



Helsingborg, Sweden



Québec, Canada



Bedford Center, South Africa



Congress Center Montreal, Canada



Teisendorf, Germany



Menlyn Park, South Africa



Galeria, Russia

*Star Cone*  
Star Cone



Mainz, Germany



Duisburg, Germany

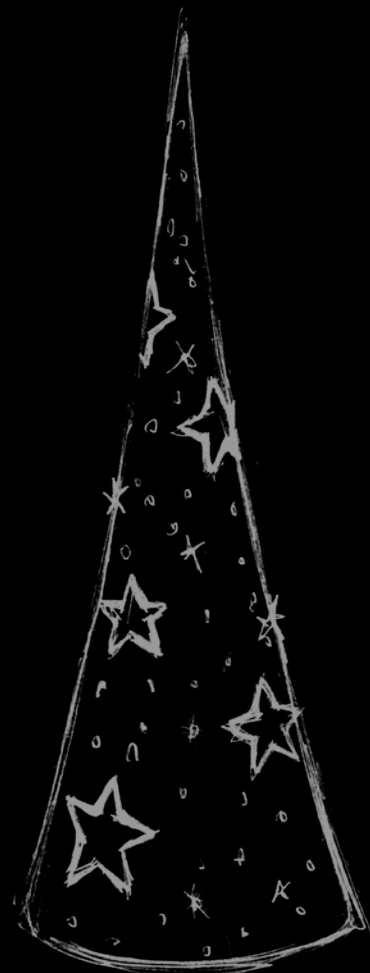



Istanbul, Turkey



Istanbul, Turkey



Białystok, Poland



Vincent Park, South Africa



Łódź, Poland



Innsbruck, Austria

# Star Ball & Sky Ball

Star Ball & Sky Ball



Usce Shopping Center, Serbia



Linden Shop, Sweden



Örebro, Sweden



Liffey Valley, Ireland



Cavendish Square, South Africa



River Park, Slovakia



# *Meridian, Meridian Light & Pearl*

Meridian, Meridian Light & Pearl



Menlyn Park, South Africa

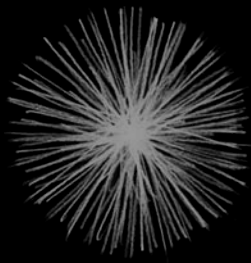

Casino, Belgium



Osaka, Japan



Vilagitas, Hungary

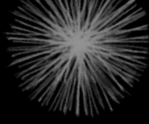

# Snow Ball @ Supernova

Snow Ball & Supernova



Almada Forum. Portugal



Nacka Forum, Sweden



Almada Forum. Portugal

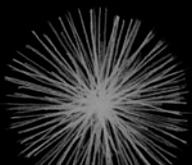

# Chandelier & Candela

Chandelier & Candela



München, Germany



Gothenburg, Sweden



Europark, Austria



Nelson Mandela Square, South Africa



Menlyn Park, South Africa



Eurovea Shopping Center, Slovakia



Manchester, UK



Nimes, France



Panora, Turkey



Panora, Turkey



Seedamm Center Pfäffikon, Switzerland



Rhodt, Germany



Rhodt, Germany

*Fountains*  
Fountains



Craiova, Romania



Bad Soden, Germany

# Air Balls & Textil Stars

Air Balls & Textil Stars



MAR Shopping, Portugal



Menlyn Park, South Africa



Gateway, South Africa



Banská Bystrica, Slovakia



Usce Shopping Center, Serbia



Christmasworld 2011



Manchester, UK

# REGISTER

<b>Code Nr.</b>	<b>Page Seite</b>	<b>Code Nr.</b>	<b>Page Seite</b>	<b>Code Nr.</b>	<b>Page Seite</b>	<b>Code Nr.</b>	<b>Page Seite</b>	<b>Code Nr.</b>	<b>Page Seite</b>	<b>Code Nr.</b>	<b>Page Seite</b>
014-008	22	014-487	123	015-024	70	018-263	63	018-412	39	244-245	23
014-009	22	014-488	123	015-025	70	018-264	63	028-001	83	248-001	111
014-010	21	014-489	123	015-026	70	018-274	67	028-002	83	248-002	111
014-011	21	014-490	121	015-027	70	018-278	67	028-003	89	248-003	111
014-013	22	014-491	121	015-028	70	018-291	63	028-004	89	248-004	111
014-014	22	014-513	63	015-029	70	018-309	33	028-009	93	248-005	111
014-017	21	014-514	101	015-030	22	018-310	33	028-010	93	248-006	115
014-032	65	014-515	101	015-032	81	018-311	33	028-011	97	248-007	115
014-033	65	014-524	121	015-044	26	018-312	33	028-012	97	248-008	115
014-062	73	014-713	127	015-045	26	018-313	41	028-013	97	248-009	115
014-063	73	014-714	127	015-046	26	018-314	45	028-014	97	248-010	115
014-064	73	014-715	127	015-047	26	018-323	33	028-019	83	248-027	115
014-065	73	014-716	127	015-048	26	018-324	33	028-021	83	248-028	111
014-066	73	014-717	127	015-050	27	018-325	37	028-022	83	248-057	113
014-100	71	014-718	127	015-051	27	018-326	37	028-024	83	248-058	113
014-101	71	014-721	127	015-052	27	018-327	37	028-039	85	248-059	113
014-102	71	014-722	127	015-053	27	018-328	37	028-040	85	248-060	113
014-103	71	014-725	127	015-054	27	018-329	49	028-045	130	248-061	113
014-104	71	014-726	127	015-055	27	018-330	49	028-048	85	248-062	113
014-105	71	014-727	127	015-056	27	018-331	49	028-049	85	248-063	113
014-106	71	014-728	127	015-057	27	018-332	49	028-050	85	444-001	116
014-107	71	014-729	127	015-058	27	018-333	51	028-052	91	444-002	116
014-233	23	014-730	127	015-059	27	018-334	51	028-053	91	444-003	116
014-234	23	014-733	127	015-060	26	018-335	49	028-056	95	923-314	142
014-244	23	014-734	127	015-061	26	018-336	49	028-057	95	923-659	142
014-246	23	014-749	127	015-063	107	018-337	51	028-058	93	931-376	139
014-248	21	014-750	127	015-064	101	018-338	53	028-059	93	931-378	139
014-249	21	014-751	127	015-065	101	018-339	53	028-060	95	931-380	139
014-253	21	014-752	127	015-066	23	018-340	53	028-061	95	931-382	139
014-261	73	014-753	127	015-067	23	018-341	53	028-062	130	931-384	139
014-262	73	014-754	127	015-068	23	018-342	57	028-063	130	931-386	139
014-266	73	014-757	127	015-069	23	018-343	57	028-064	87	931-388	139
014-267	73	014-758	127	015-070	23	018-344	57	028-065	87	931-390	139
014-268	73	014-761	127	015-071	23	018-345	57	028-067	89	931-392	139
014-269	73	014-762	127	015-072	23	018-346	59	028-068	89	931-394	139
014-270	73	014-763	127	015-073	23	018-347	59	028-069	89	931-420	140
014-307	21	014-764	127	015-074	101	018-348	57	028-070	89	931-423	140
014-308	21	014-765	127	015-075	101	018-349	57	032-011	147	931-425	140
014-309	22	014-766	127	015-076	101	018-350	61	032-012	147	931-427	140
014-310	22	014-769	127	015-077	101	018-351	61	032-015	144	931-429	140
014-316	21	014-770	127	015-078	71	018-352	61	032-016	147	931-431	140
014-370	125	014-833	49	015-079	71	018-353	61	032-017	147	931-433	140
014-371	125	014-834	49	015-080	71	018-357	33	032-018	147	931-435	140
014-372	125	014-835	49	015-081	71	018-358	33	032-024	147	931-437	140
014-373	125	014-836	51	015-082	81	018-359	35	032-025	144	931-439	140
014-375	125	014-854	63	015-083	81	018-360	35	032-026	147	931-478	126
014-376	125	014-855	49	015-084	81	018-361	35	032-207	147	931-479	126
014-377	125	014-869	63	015-085	81	018-362	35	032-208	147	931-480	126
014-378	125	014-870	63	015-519	79	018-363	35	032-209	147	931-481	126
014-379	125	014-872	131	015-587	24	018-364	35	032-210	148	931-482	126
014-380	125	014-873	131	015-588	24	018-365	35	032-215	148	931-483	126
014-412	49	014-919	21	015-589	24	018-366	37	032-217	142	931-486	126
014-413	49	014-920	21	015-590	24	018-367	37	032-218	142	931-643	131
014-414	49	014-927	53	015-591	25	018-368	39	032-221	149	931-644	131
014-415	49	014-928	53	015-592	25	018-369	39	032-222	149	931-863	131
014-418	23	014-929	53	015-593	79	018-373	49	112-025	65	931-864	131
014-419	23	014-930	53	015-594	130	018-374	49	112-113	65	931-866	131
014-443	21	014-936	63	015-595	130	018-378	49	244-002	117	931-881	131
014-444	73	014-937	101	015-599	53	018-382	51	244-003	117	931-894	139
014-445	73	014-938	101	015-600	53	018-384	53	244-005	117	931-895	139
014-446	73	014-942	107	015-618	101	018-385	53	244-006	117	931-896	139
014-447	73	014-943	107	015-620	22	018-390	57	244-009	116	931-897	139
014-448	73	014-947	79	015-625	123	018-396	59	244-010	116	931-898	139
014-449	73	014-948	79	015-626	123	018-397	59	244-014	117	932-439	182
014-450	73	014-949	79	015-627	123	018-398	61	244-015	117	932-569	199
014-452	101	015-010	81	017-040	107	018-400	61	244-023	117	932-570	199
014-453	101	015-011	81	017-041	103	018-402	39	244-033	23	932-572	198
014-454	101	015-012	81	017-042	103	018-403	39	244-034	23	932-625	205
014-455	101	015-013	81	017-043	103	018-404	44	244-217	117	932-628	189
014-467	49	015-014	81	017-044	103	018-405	44	244-218	117	932-635	195
014-468	49	015-015	79	017-045	103	018-406	43	244-219	117	932-726	182
014-469	51	015-017	129	017-046	107	018-407	43	244-230	23	932-730	199
014-470	51	015-018	129	017-047	107	018-408	39	244-231	23	932-756	190
014-471	51	015-019	81	017-050	105	018-409	39	244-232	150	932-760	203
014-485	121	015-022	73	018-237	31	018-410	39	244-233	150	932-764	183
014-486	121	015-023	73	018-238	31	018-411	39	244-244	23	932-765	183

<b>Code Nr.</b>	<b>Page Seite</b>	<b>Code Nr.</b>	<b>Page Seite</b>	<b>Code Nr.</b>	<b>Page Seite</b>	<b>Code Nr.</b>	<b>Page Seite</b>	<b>Code old Nr. alt</b>	<b>Code new Nr. neu</b>	<b>Page Seite</b>
932-766	183	932-949	155	933-818	149	938-008	138	014-500-LED-WW	015-625	123
932-767	186	932-950	155	933-819	149	938-009	138	014-501-LED-WW	015-626	123
932-770	186	932-953	156	933-820	149	938-010	138	014-502-LED-WW	015-627	123
932-773	191	932-954	156	933-821	149	938-024	131	014-922	015-587	24
932-775	198	932-956	157	933-822	149	938-025	131	014-923	015-588	24
932-776	198	932-957	156	933-823	149	938-036	131	014-946	015-593	79
932-782	190	932-958	156	933-824	149	938-037	131	015-034	015-589	24
932-790	195	932-959	198	933-825	205	938-073	142	015-035	015-590	24
932-792	199	932-960	198	933-826	144	941-002	151	015-036	015-591	25
932-793	199	932-961	200	933-827	144	941-003	151	015-037	015-592	25
932-817	201	932-962	200	933-828	145	941-004	151	017-022	017-041	103
932-826	191	932-995	157	933-829	145	941-005	151	017-023	017-043	103
932-836	194	933-264	147	933-830	147	941-006	151	017-030	017-042	103
932-838	183	933-415	148	933-831	148	941-007	151	017-031	017-044	103
932-841	186	933-497	144	933-832	148	941-009	151	017-032	017-045	103
932-842	186	933-499	148	933-833	148	941-010	151	017-033	017-046	107
932-843	186	933-500	148	933-834	148	941-011	151	017-034	017-047	107
932-844	191	933-512	149	933-835	192	941-017	151	018-014	018-348	57
932-845	189	933-517	149	933-836	194	941-019	213	018-015	018-390	57
932-848	190	933-518	149	933-838	189	941-026	213	018-036	018-359	35
932-849	190	933-519	149	933-842	187	941-027	213	018-037	018-360	35
932-850	190	933-530	186	933-848	190	941-028	213	018-038	018-361	35
932-851	192	933-555	187	933-851	192	941-029	213	018-040	018-323	33
932-854	195	933-556	187	933-860	200	941-033	151	018-041	018-324	33
932-856	195	933-583	194	933-863	190	941-061	151	018-042	018-362	35
932-860	198	933-625	205	933-880	165	951-001	211	018-075	018-405	44
932-863	199	933-632	202	933-881	165	951-002	211	018-084	018-397	59
932-865	205	933-662	142	933-883	165	951-003	211	018-085	018-396	59
932-867	162	933-665	142	933-884	166	951-005	211	018-090	018-335	49
932-868	162	933-668	142	933-885	166	951-007	209	018-091	018-373	49
932-869	162	933-680	145	933-886	166	951-012	209	018-092	018-336	49
932-870	162	933-681	145	933-887	167	951-013	209	018-093	018-378	49
932-871	163	933-683	144	933-888	167	951-014	209	018-155	018-311	33
932-872	163	933-684	144	933-889	167	951-015	211	018-156	018-312	33
932-873	163	933-685	144	933-890	169	951-016	211	018-157	018-329	49
932-874	163	933-689	147	933-891	168	951-019	209	018-158	018-331	49
932-875	164	933-698	143	933-893	170	951-021	209	018-159	018-333	51
932-876	164	933-699	143	933-894	170	952-001	211	018-160	018-337	51
932-877	164	933-704	147	933-895	170	952-002	211	018-161	018-382	51
932-878	164	933-705	147	933-897	204	952-003	211	018-162	018-344	57
932-879	164	933-716	186	933-898	204	952-005	211	018-163	018-342	57
932-897	171	933-724	147	933-899	172	952-007	209	018-165	018-313	41
932-898	171	933-756	190	933-900	172	952-012	209	018-239	018-310	33
932-906	176	933-760	203	933-901	172	952-013	209	018-240	018-309	33
932-907	176	933-761	148	933-902	173	952-014	209	018-243	018-404	44
932-908	176	933-762	182	933-903	173	952-015	211	018-244	018-330	49
932-909	176	933-763	182	933-904	173	952-016	211	018-245	018-374	49
932-910	177	933-764	183	933-905	173	952-021	209	018-246	018-332	49
932-911	177	933-765	183	933-917	182	953-001	211	018-247	018-334	51
932-912	177	933-769	191	933-918	182	953-002	211	018-249	018-325	37
932-913	178	933-772	188	933-939	160	953-003	211	018-251	018-346	59
932-914	178	933-773	201	933-940	160	953-005	211	018-252	018-347	59
932-915	178	933-775	190	933-941	161	953-008	210	018-253	018-343	57
932-916	178	933-776	192	933-942	161	953-010	210	018-255	018-345	57
932-919	179	933-777	192	933-944	203	953-020	210	018-257	018-326	37
932-920	179	933-778	192	933-945	154	953-021	209	018-258	018-327	37
932-921	179	933-779	187	933-946	154	954-001	211	018-259	018-328	37
932-922	179	933-781	143	933-947	155	954-002	211	018-279	018-365	35
932-923	180	933-783	204	933-948	155	954-003	211	018-280	018-364	35
932-924	180	933-784	204	933-949	155	954-005	211	018-281	018-363	35
932-925	180	933-787	203	933-950	155	954-007	209	018-282	018-338	53
932-926	181	933-788	203	933-951	156	954-008	210	018-283	018-339	53
932-927	181	933-802	187	933-952	156	954-010	210	018-284	018-340	53
932-928	181	933-803	187	933-953	156	954-012	209	018-285	018-341	53
932-929	171	933-804	143	933-954	156	954-013	209	018-286	018-349	57
932-932	158	933-806	144	933-956	157	954-014	209	018-287	018-350	61
932-933	158	933-807	144	933-957	149	954-015	211	018-288	018-351	61
932-934	158	933-808	145	933-958	149	954-016	211	018-289	018-352	61
932-935	159	933-809	147	933-995	157	954-019	209	018-290	018-353	61
932-936	159	933-810	146	938-001	138	954-020	210	028-005	028-068	89
932-937	159	933-811	146	938-002	138	954-021	209	028-006	028-067	89
932-938	159	933-812	146	938-003	138			028-007	028-070	89
932-945	154	933-813	146	938-004	138			028-008	028-069	89
932-946	154	933-815	146	938-005	138					
932-947	155	933-816	146	938-006	138					
932-948	155	933-817	201	938-007	138					



